

Service Manual

Air Conditioner

CS-HE9DKE CU-HE9DKE
CS-HE12DKE CU-HE12DKE

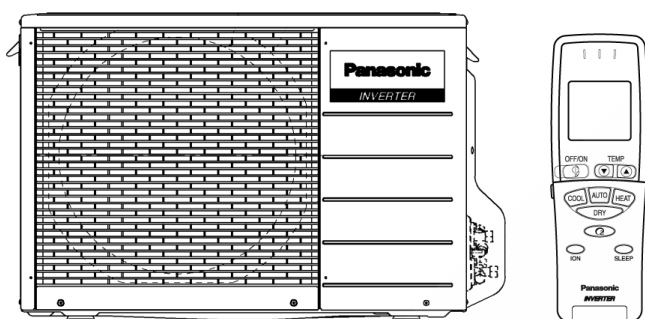
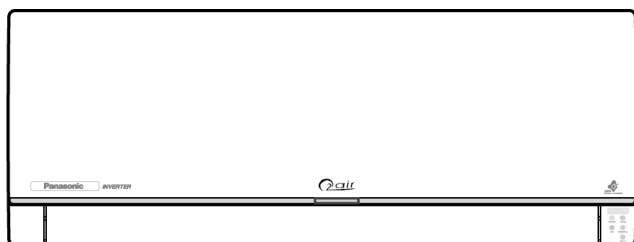

⚠ WARNING

This service information is designed for experienced repair technicians only and is not designed for use by the general public. It does not contain warnings or cautions to advise non-technical individuals of potential dangers in attempting to service a product. Products powered by electricity should be serviced or repaired only by experienced professional technicians. Any attempt to service or repair the product or products dealt with in this service information by anyone else could result in serious injury or death.

⚠ PRECAUTION OF LOW TEMPERATURE

In order to avoid frostbite, be assured of no refrigerant leakage during the installation or repairing of refrigeration circuit.

CONTENTS

	Page		Page
1 Features	2	7.2. Outdoor Unit	15
2 Functions	3	8 Electronic Circuit Diagram	16
2.1. Remote Control	3	8.1. Indoor Unit / Remote Controller	16
2.2. Indoor Unit	4	8.2. Outdoor Unit	18
2.3. Outdoor unit	5	9 Operation Details	20
3 Product Specifications	6	9.1. Basic Function	20
4 Dimensions	10	9.2. Indoor Power Relay Control	21
4.1. Indoor Unit / Remote Control	10	9.3. Room Temperature Control (Compressor Control)	22
4.2. Outdoor Unit	11	9.4. Airflow Direction Control	23
5 Refrigeration Cycle Diagram	12	9.5. Quiet operation (Cooling Mode / Cooling area of Dry Mode)	26
6 Block Diagram	13	9.6. Indoor Fan Control	28
7 Wiring Diagram	14	9.7. Powerful Operation	30
7.1. Indoor Unit	14		

Panasonic®

© 2005 Matsushita Electric Industrial Co., Ltd. All rights reserved. Unauthorized copying and distribution is a violation of law.

9.8. Automatic Operation	31	12.2. Tools For Installing/Service Refrigerant Piping	56
9.9. Sleep Timer Operation	32	12.3. Refrigerant Piping Work	60
9.10. Timer Operation	32	12.4. Installation, Transferring, Servicing	63
9.11. Auto Restart Control	32	13 Servicing Information	67
9.12. Ionizer Operation	33	13.1. About Lead Solder (PbF)	67
9.13. Oxygen Enrich Operation	34	13.2. Troubleshooting	68
9.14. Deice Control <Heating>	36	13.3. Disassembly of Parts	72
9.15. Protection Control	37	14 Technical Data	81
10 Operating Instructions	39	14.1. Operation Characteristics	81
11 Installation Instructions	45	14.2. Sensible Capacity Chart	83
11.1. Safety Precautions	45	15 Exploded View and Replacement Parts List	84
11.2. Indoor Unit	48	15.1. Exploded View (Indoor Unit)	84
11.3. Outdoor Unit	52	15.2. Replacement Parts List (Indoor Unit)	85
12 Installation and Servicing Air Conditioner Using R410A	55	15.3. Exploded View (Outdoor Unit)	86
12.1. Outline	55	15.4. Replacement Parts List (Outdoor Unit)	87

1 Features

• Product

- Telecommunication Support.
- Air Swing to adjust vertical or horizontal airflow louver.
- Four modes of operation selection.
- Air filter with function to reduce dust and smoke.
- Supersonic air purifying device (Super Alleru-buster) operation.
- Remote control unit holder.
- Remote control self-illuminating button.
- Ionizer control to provide fresh air effect by generating negative ion.
- Powerful mode to achieve setting temperature quickly room.
- Quiet mode to provide quiet operation (Lo: -3dB).
- Oxygen mode to supply oxygen enrich air to indoor room.
- 24-hour real-timer setting.
- Long installation piping up to 15 meters.
- Guard net provided in Outdoor unit

• Quality Improvement

- Random auto restart after power failure for safety restart operation.
- Blue Coated Condenser for high resistance to corrosion.

• Serviceability

- Removable and washable front panel.
- Breakdown self diagnosis function.

• Environmental Protection

- Non-ozone depletion substances refrigerant (R410A).

2 Functions

2.1. Remote Control

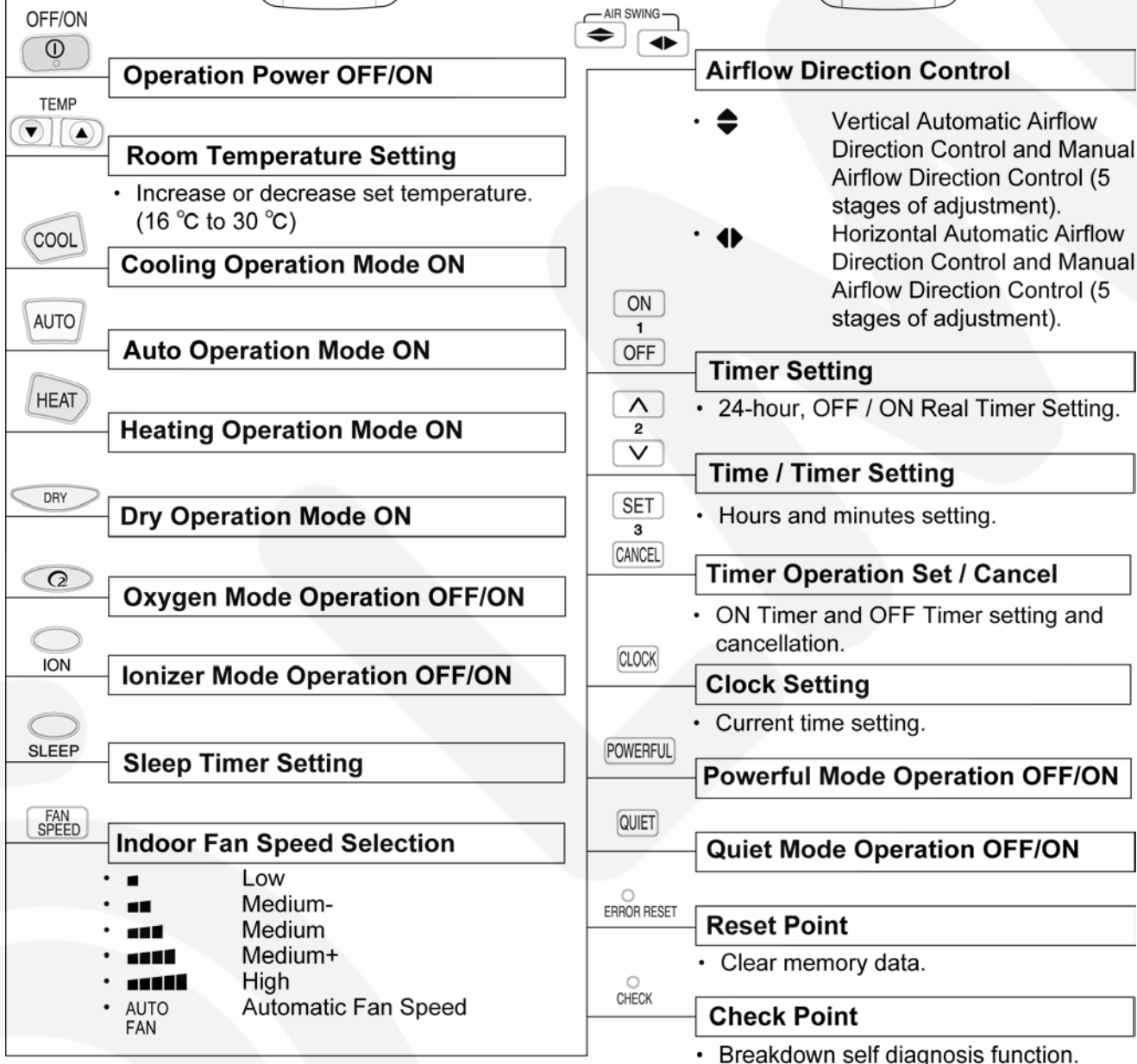
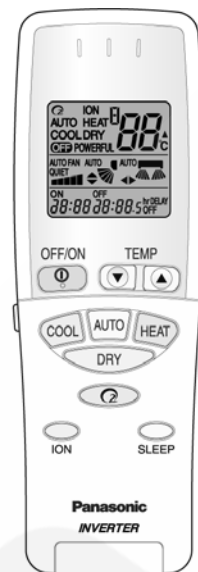
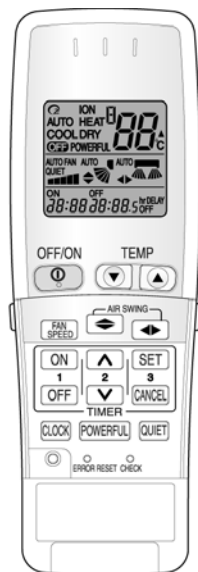

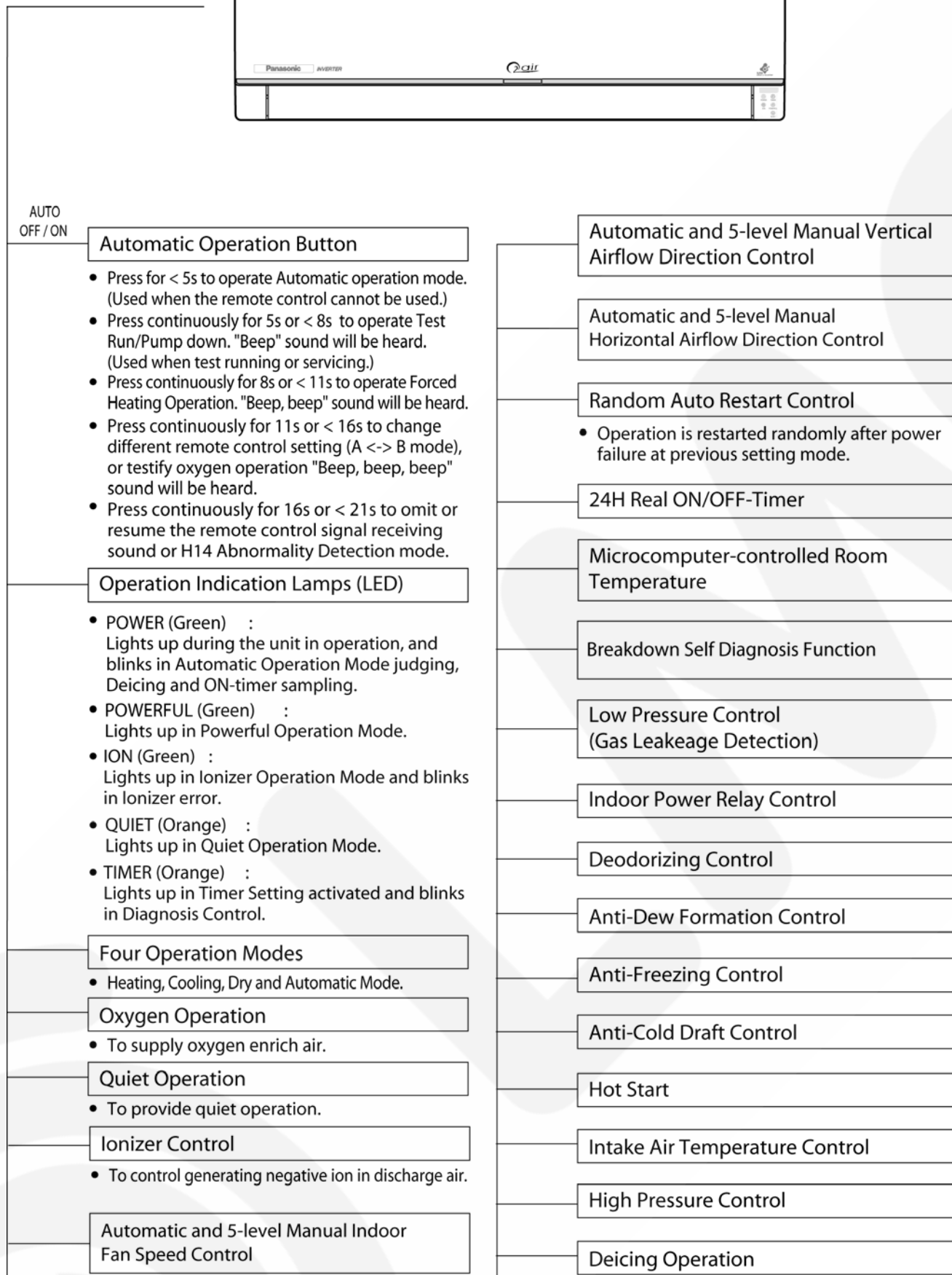
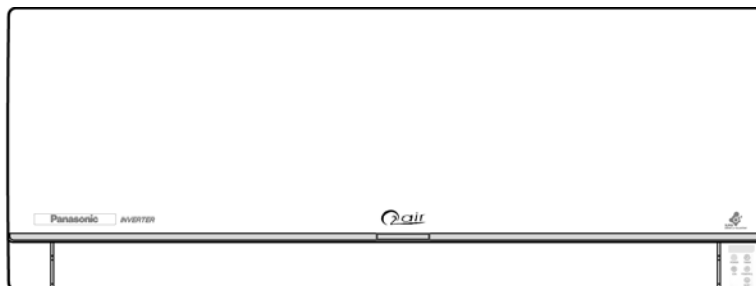

2.2. Indoor Unit

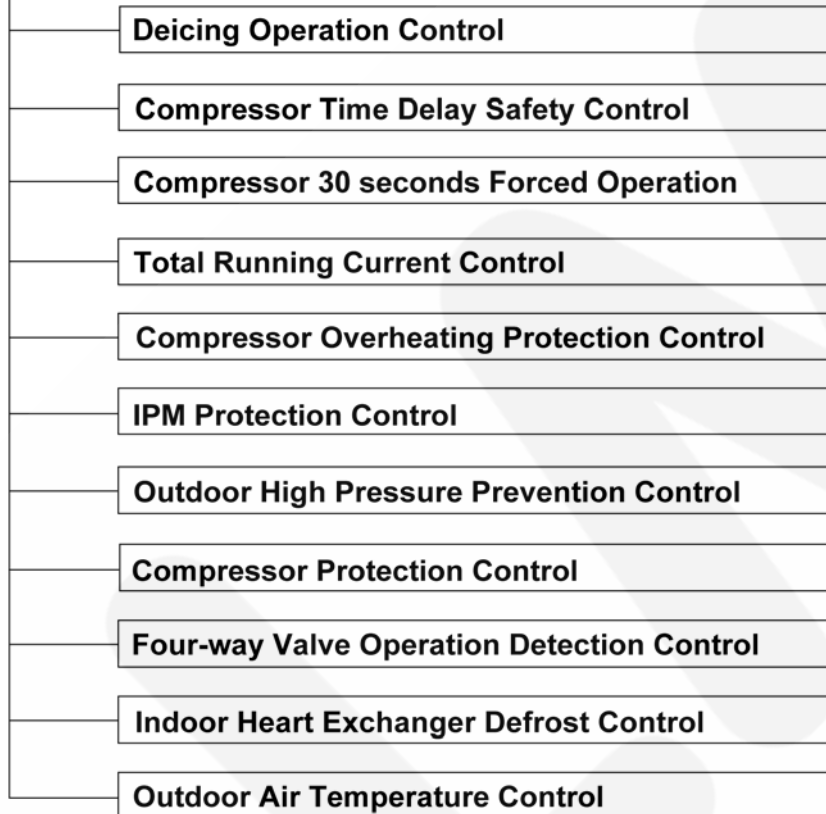
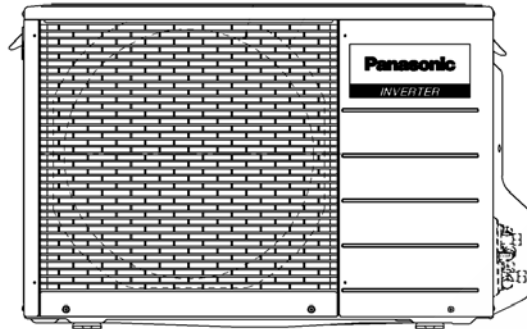

2.3. Outdoor unit



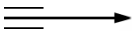

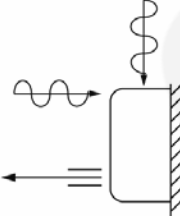
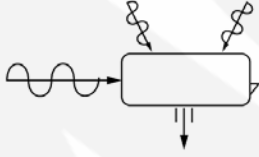
3 Product Specifications

		Unit	CS-HE9DKE	CU-HE9DKE
Cooling Capacity		kW kcal/h BTU/h	2.60 (0.60 - 3.00) 2,240 (520 - 2,580) 8,870 (2,050 - 10,200)	
Heating Capacity		kW kcal/h BTU/h	3.60 (0.60 - 6.50) 3,100 (520 - 5,590) 12,300 (2,050 - 22,080)	
Moisture Removal		l/h Pint/h	1.5 (3.2)	
Power Source		Phase V Cycle	Single 230/240 50	
Airflow Method		OUTLET  INTAKE 	SIDE VIEW 	TOP VIEW 
Air Volume	Indoor Air (Lo)	m ³ /min (cfm)	Cooling; 5.2 (180) Heating; 6.3 (220)	—
	Indoor Air (Me)	m ³ /min (cfm)	Cooling; 7.9 (280) Heating; 8.8 (310)	—
	Indoor Air (Hi)	m ³ /min (cfm)	Cooling; 10.5 (370) Heating; 11.5 (410)	Cooling; 23.8 (840) Heating; 23.1 (820)
Noise Level		dB (A)	Cooling; High 39, Low 26 Heating; High 40, Low 27	Cooling; 46 Heating; 47
		Power level dB	Cooling; High 50 Heating; High 51	Cooling; High 59 Heating; High 60
Electrical Data	Input	W	Cooling; 510 (120 - 700) Heating; 690 (115 - 1,720)	
	Running Current	A	Cooling; 2.6 Heating; 3.5	
	EER	W/W (kcal/hw), BTU/hw	Cooling; 5.10 (4.39), 17.4	
	COP	W/W (kcal/hw), BTU/hw	Heating; 5.22 (4.49), 17.8	
	Starting Current	A	3.6	
Piping Connection Port (Flare piping)		inch inch	G ; Half Union 3/8" L ; Half Union 1/4"	G ; 3-way valve 3/8" L ; 2-way valve 1/4"
Pipe Size (Flare piping)		inch inch	G (gas side) ; 3/8" L (liquid side) ; 1/4"	G (gas side) ; 3/8" L (liquid side) ; 1/4"

		Unit	CS-HE9DKE	CU-HE9DKE	
Drain Hose	Inner diameter	mm	16	—	
	Length	m	0.65	—	
Power Cord Length			1.8 m	—	
Number of core-wire			3-core wires × 1.0 mm ²	—	
Dimensions	Height	inch (mm)	11 - 23/32 (298)	21 - 1/4 (540)	
	Width	inch (mm)	34 - 8/32 (870)	30 - 23/32 (780)	
	Depth	inch (mm)	7 - 27/32 (199)	11 - 3/8 (289)	
Net Weight		lb (kg)	24 (11)	79 (36)	
Compressor	Type		—	Involute scroll	
	Motor Type		—	Brushless (4-poles)	
	Rated Output	W	—	750	
Air Circulation	Type		Cross-flow Fan	Propeller Fan	
	Material		AS + Glass Fiber 20%	P.P	
	Motor Type		Transistor (8-poles)	Induction (8-poles)	
	Input	W	—	—	
	Rate Output	W	30	40	
	Fan Speed	Lo (Cool/Heat)	rpm	660 / 750	—
		Me (Cool/Heat)	rpm	880 / 950	—
Hi (Cool/Heat)		rpm	1,090 / 1,150	790 / 770	
Heat Exchanger	Description		Evaporator	Condenser	
	Tube material		Copper	Copper	
	Fin material		Aluminium (Pre Coat)	Aluminium (Blue Coated)	
	Fin Type		Slit Fin	Corrugated Fin	
	Row / Stage		(Plate fin configuration, forced draft) 3 / 16	2 / 24	
	FPI		20	16.5	
	Size (W × H × L)	mm	671 × 322.6 × 30.9	816.9 × 504 × 36.4	
Refrigerant Control Device			—	Capillary Tube	
Refrigeration Oil		(c.c)	—	RB68A (400)	
Refrigerant (R410A)		g (oz)	—	1, 190 (42.0)	
Thermostat			Electronic Control	Electronic Control	
Protection Device			Electronic Control	Electronic Control	
Air Filter	Material Style		P.P. Honeycomb	—	

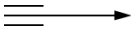
- Specifications are subject to change without notice for further improvement.

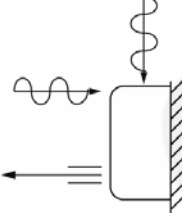
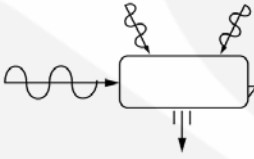
		Unit	CS-HE12DKE	CU-HE12DKE
Cooling Capacity		kW kcal/h BTU/h	3.50 (0.60 - 4.00) 3,010 (520 - 3,440) 11,900 (2,050 - 13,600)	
Heating Capacity		kW kcal/h BTU/h	4.80 (0.60 - 7.70) 4,130 (520 - 6,620) 16,400 (2,050 - 26,100)	
Moisture Removal		l/h Pint/h	2.0 (4.2)	
Power Source		Phase V Cycle	Single 230/240 50	
Airflow Method		<p>OUTLET</p>  <p>INTAKE</p> 	<p>SIDE VIEW</p> 	<p>TOP VIEW</p> 
Air Volume	Indoor Air (Lo)	m ³ /min (cfm)	Cooling; 6.2 (220) Heating; 7.8 (280)	—
	Indoor Air (Me)	m ³ /min (cfm)	Cooling; 8.4 (300) Heating; 10.0 (350)	—
	Indoor Air (Hi)	m ³ /min (cfm)	Cooling; 11.3 (400) Heating; 12.5 (440)	Cooling; 23.8 (840) Heating; 23.8 (840)
Noise Level		dB (A)	Cooling; High 42, Low 29 Heating; High 42, Low 33	Cooling; 48 Heating; 50
		Power level dB	Cooling; High 53 Heating; High 53	Cooling; High 61 Heating; High 63
Electrical Data	Input	W	Cooling; 850 (120 - 1,050) Heating; 1,040 (115 - 2,280)	
	Running Current	A	Cooling; 4.2 Heating; 5.0	
	EER	W/W (kcal/hw), BTU/hw	Cooling; 4.12 (3.54), 14.0	
	COP	W/W (kcal/hw), BTU/hw	Heating; 4.62 (3.97), 15.8	
	Starting Current	A	5	
Piping Connection Port (Flare piping)		inch inch	G ; Half Union 1/2" L ; Half Union 1/4"	G ; 3-way valve 1/2" L ; 2-way valve 1/4"
Pipe Size (Flare piping)		inch inch	G (gas side) ; 1/2" L (liquid side) ; 1/4"	G (gas side) ; 1/2" L (liquid side) ; 1/4"
Drain Hose	Inner diameter	mm	16	
	Length	m	0.65	
Power Cord Length			1.8 m	
Number of core-wire			3-core wires × 1.5 mm ²	

		Unit	CS-HE12DKE	CU-HE12DKE	
Dimensions	Height	inch (mm)	11 - 23/32 (298)	21 - 1/4 (540)	
	Width	inch (mm)	34 - 8/32 (870)	30 - 23/32 (780)	
	Depth	inch (mm)	7 - 27/32 (199)	11 - 3/8 (289)	
Net Weight		lb (kg)	24 (11)	82 (37)	
Compressor	Type		—	Involute scroll	
	Motor Type		—	Brushless (4-poles)	
	Rated Output	W	—	1,100	
Air Circulation	Type		Cross-flow Fan	Propeller Fan	
	Material		AS + Glass Fiber 20%	P.P	
	Motor Type		Transistor (8-poles)	Induction (8-poles)	
	Input	W	—	—	
	Rate Output	W	30	40	
	Fan Speed	Lo (Cool/Heat)	rpm	740 / 870	—
		Me (Cool/Heat)	rpm	920 / 1,050	—
Hi (Cool/Heat)		rpm	1,110 / 1,230	790 / 790	
Heat Exchanger	Description		Evaporator	Condenser	
	Tube material		Copper	Copper	
	Fin material		Aluminium (Pre Coat)	Aluminium (Blue Coated)	
	Fin Type		Slit Fin	Corrugated Fin	
	Row / Stage		(Plate fin configuration, forced draft) 3 / 16	2 / 24	
	FPI		20	16.5	
	Size (W × H × L)	mm	671 × 322.6 × 30.9	671 × 322.6 × 30.9	
Refrigerant Control Device			—	Capillary Tube	
Refrigeration Oil		(c.c)	—	RB68A (400)	
Refrigerant (R410A)		g (oz)	—	1,160 (40.9)	
Thermostat			Electronic Control	Electronic Control	
Protection Device			Electronic Control	Electronic Control	
Air Filter	Material Style		P.P. Honeycomb	—	

- Specifications are subject to change without notice for further improvement.

4 Dimensions

4.1. Indoor Unit / Remote Control

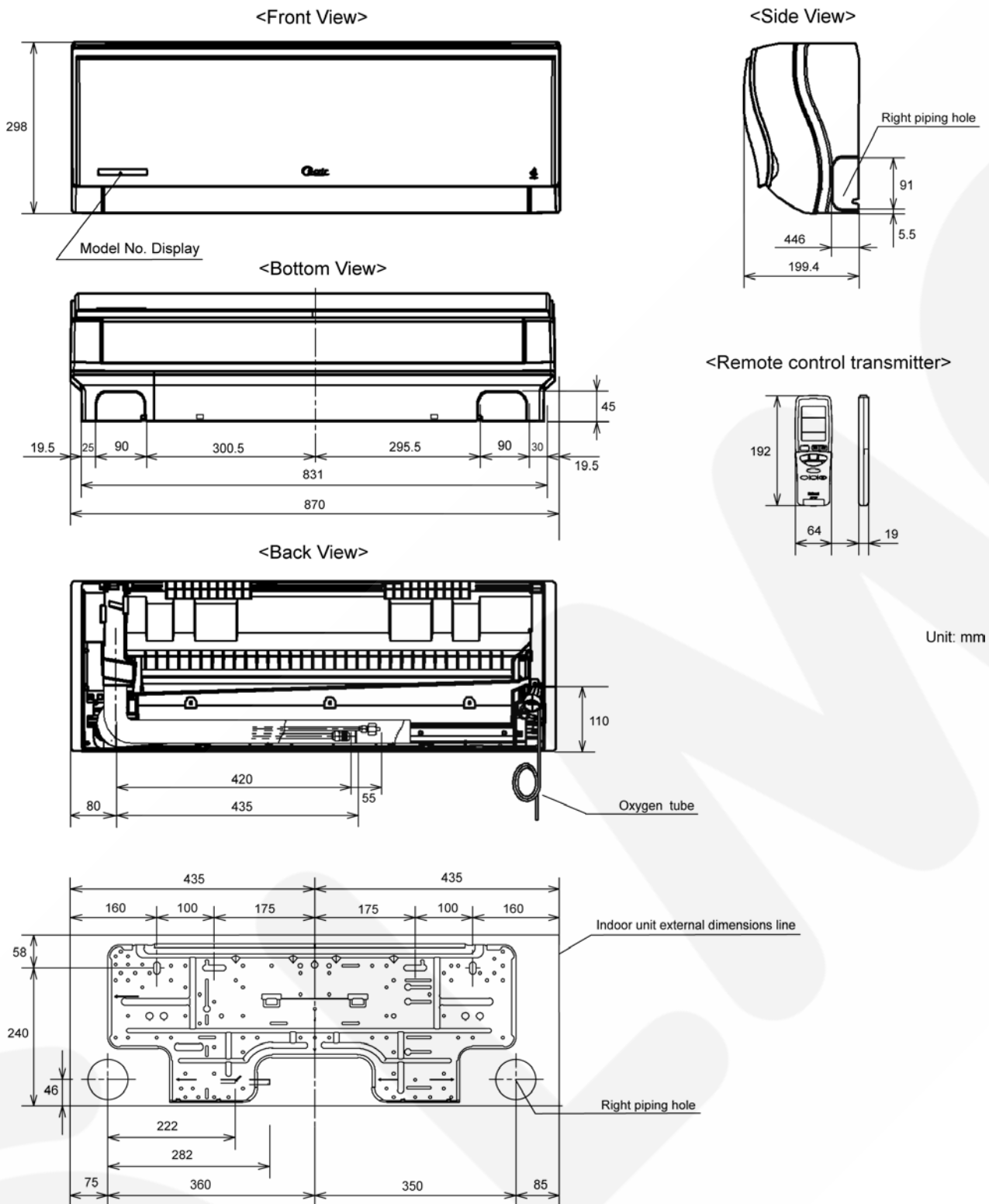

Relative position between the indoor unit and the installation plate <Front View>

4.2. Outdoor Unit

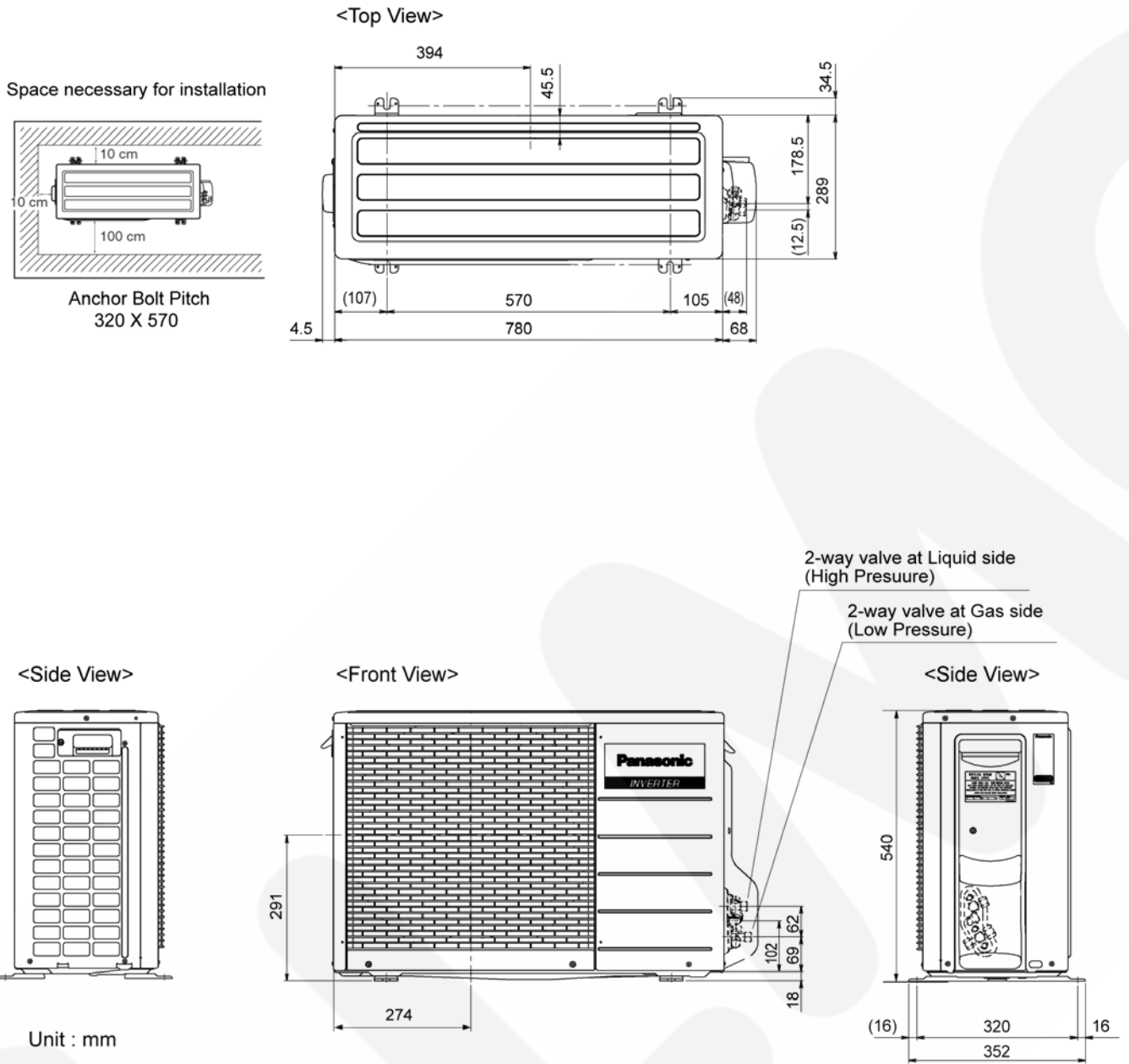

5 Refrigeration Cycle Diagram

CS-HE9DKE CU-HE9DKE
 CS-HE12DKE CU-HE12DKE

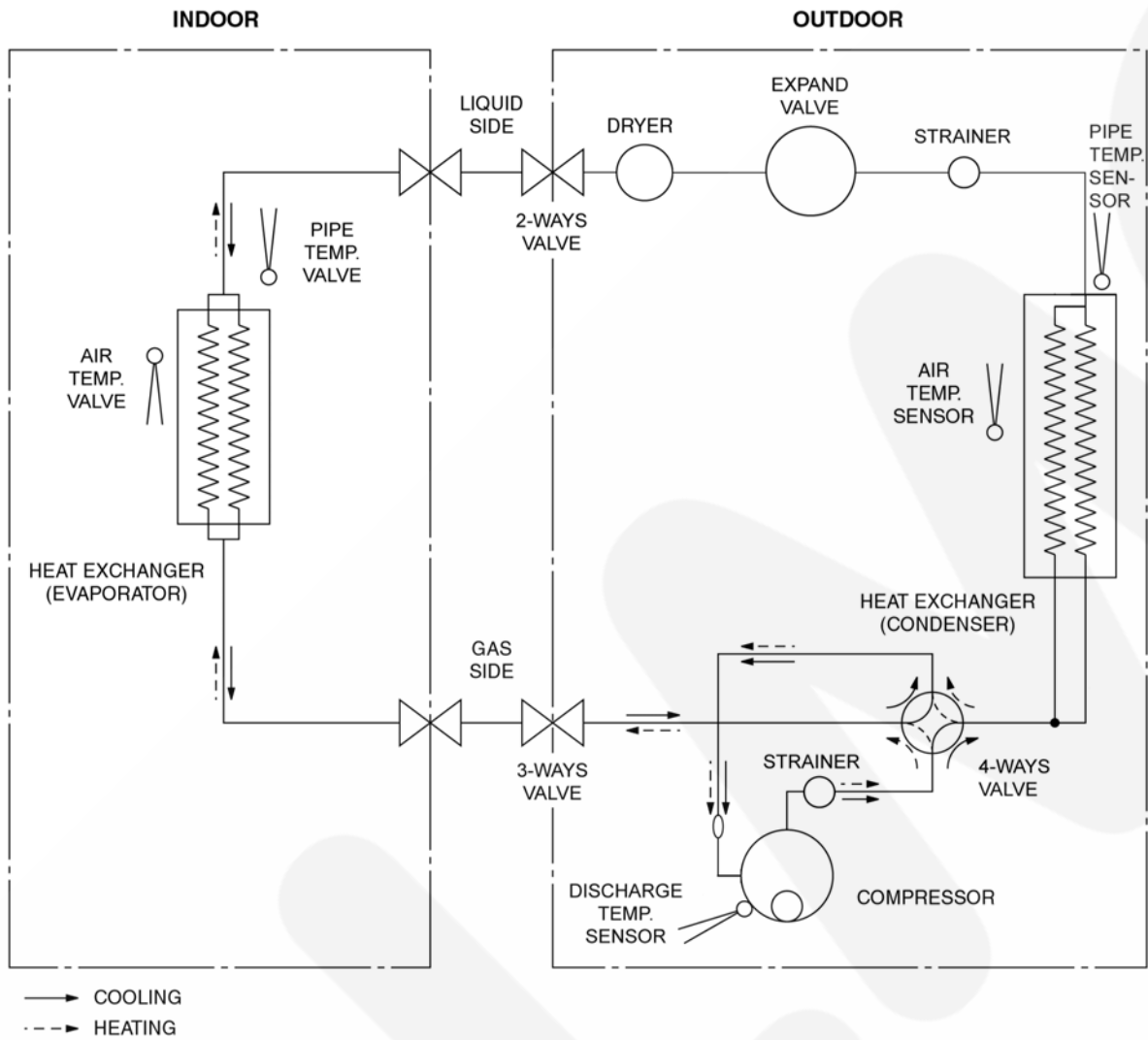

6 Block Diagram

CS-HE9DKE CU-HE9DKE
 CS-HE12DKE CU-HE12DKE

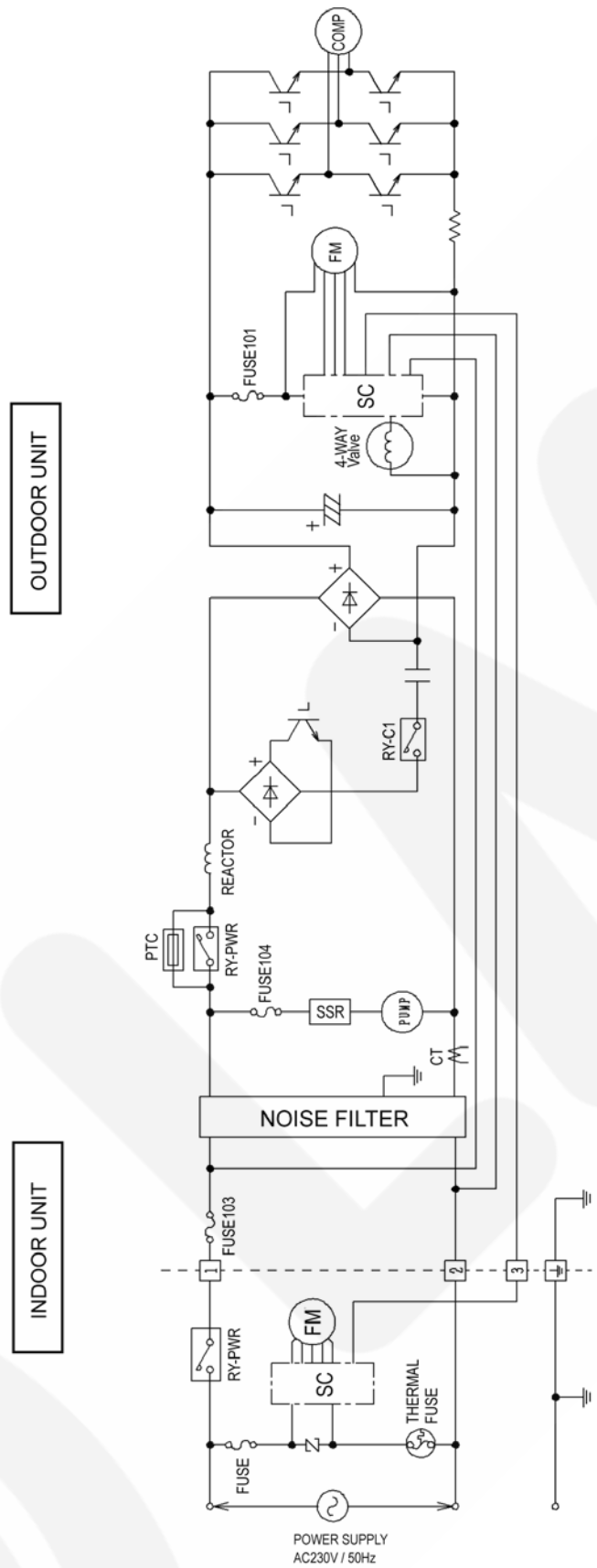

✱ [] Indicates the electronic control unit.

✱ *C* Indicates the number of core wires. (Example: 5C=5 core wires)

7 Wiring Diagram

7.1. Indoor Unit

CS-HE9DKE / CS-HE12DKE

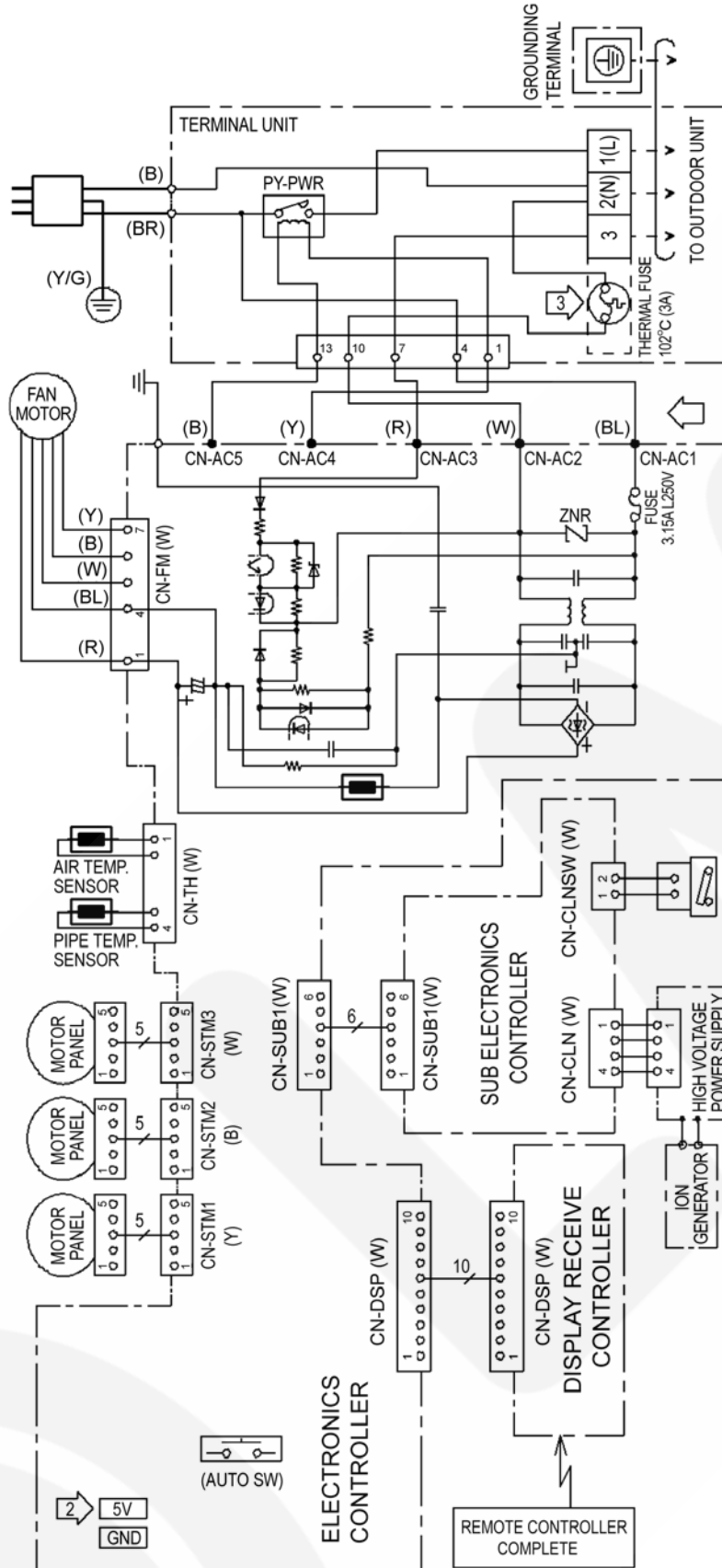

- REMARKS
- B: BLUE
 - BL: BLACK
 - BR: BROWN
 - G: GREEN
 - GR: GRAY
 - O: ORANGE
 - R: RED
 - P: PINK
 - WH: WHITE
 - Y: YELLOW
 - Y/G: YELLOW / GREEN

7.2. Outdoor Unit

CU-HE9DKE / CU-HE12DKE

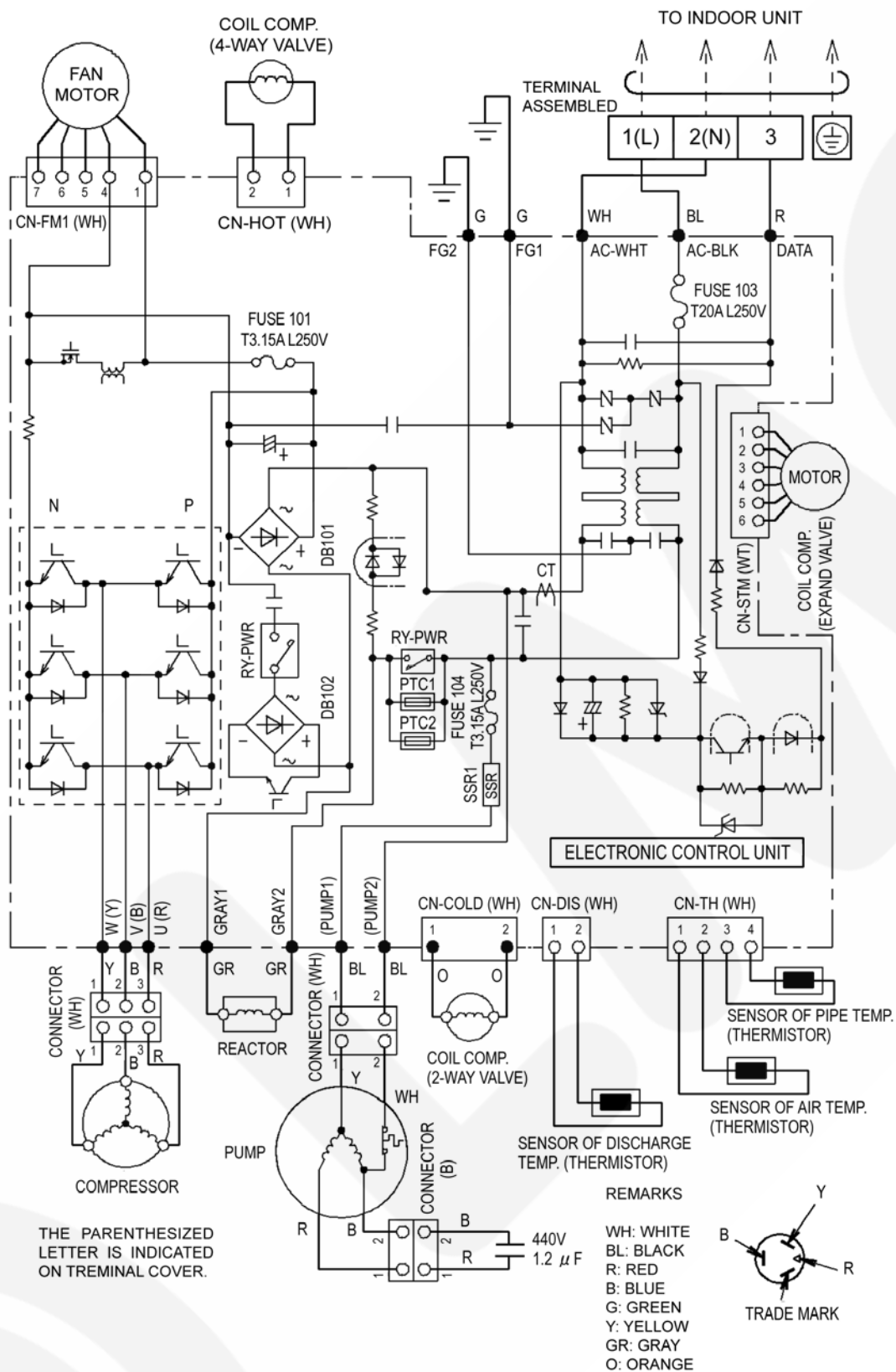

8 Electronic Circuit Diagram

8.1. Indoor Unit / Remote Controller

CS-HE9DKE / CS-HE12DKE

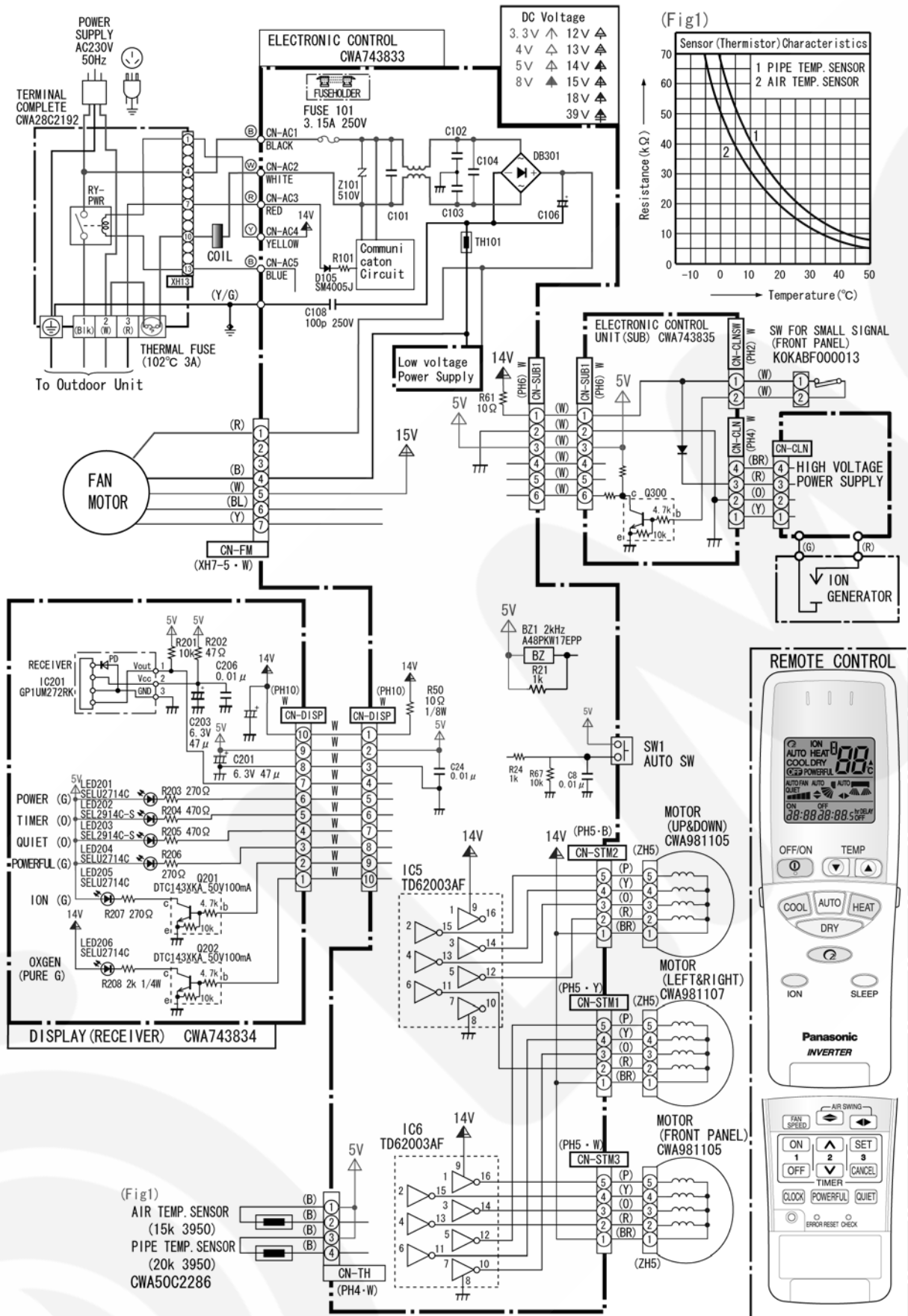

Printed Circuit Board for CS-HE9DKE / CS-HE12DKE

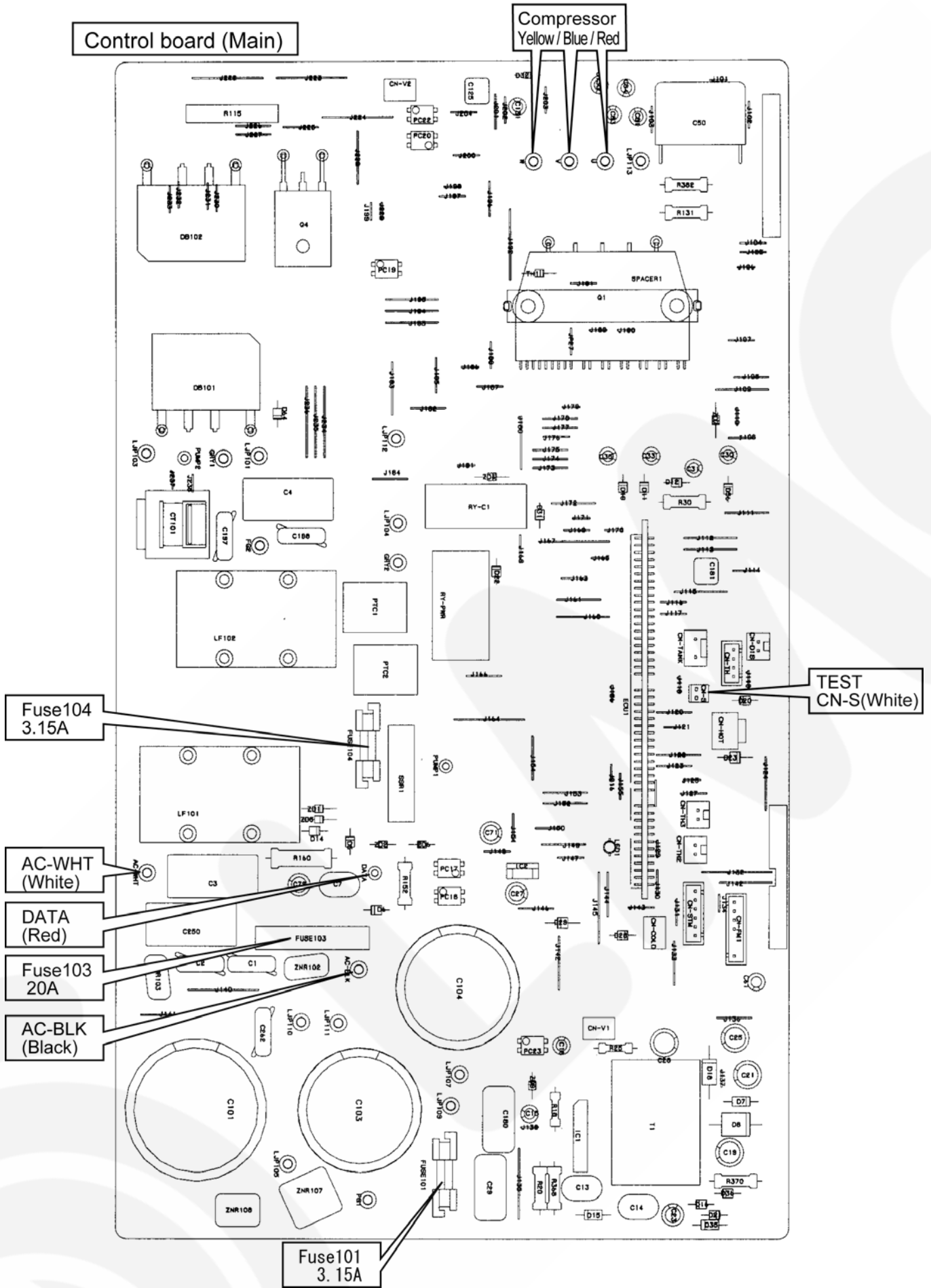

8.2. Outdoor Unit

CU-HE9DKE / CU-HE12DKE

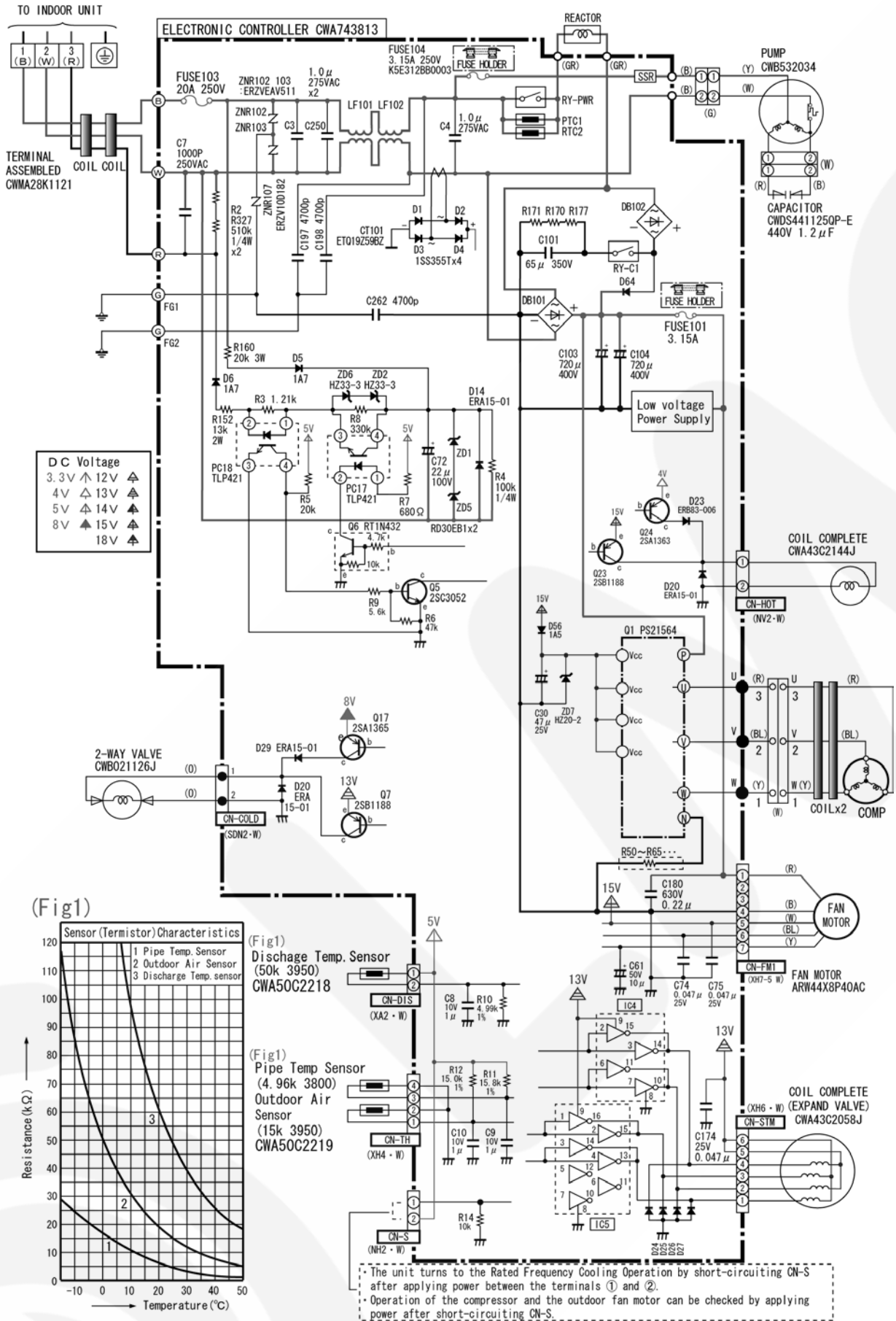

Printed Circuit Board for CU-HE9DKE / CU-HE12DKE

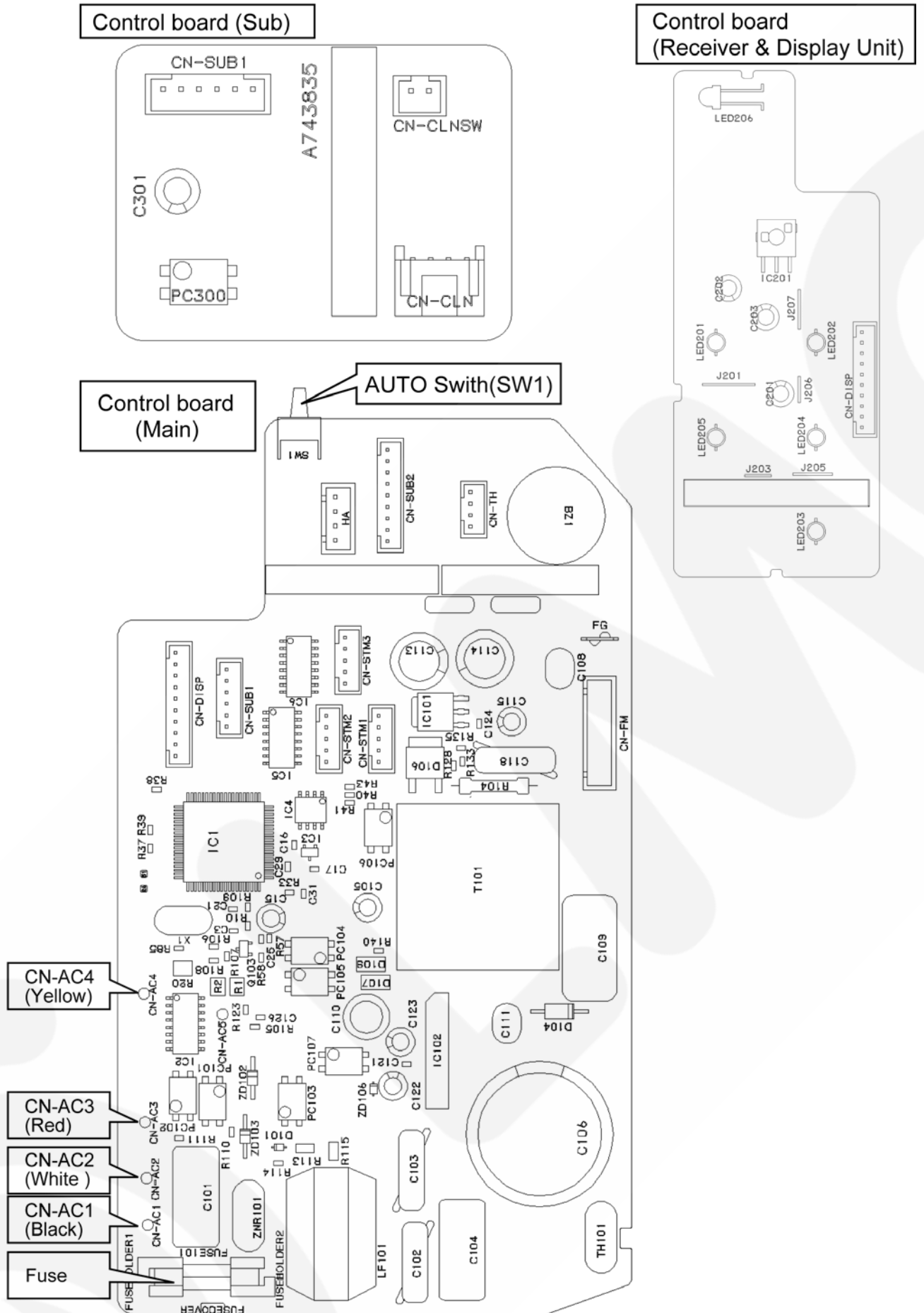

9 Operation Details

9.1. Basic Function

Inverter control, which equipped with a microcomputer in determining the most suitable operating mode as time passes, automatically adjusts output power for maximum comfort always. In order to achieve the suitable operating mode, the microcomputer maintains the set temperature by measuring the temperature of the environment and performing temperature shifting. The compressor at outdoor unit is operating following the frequency instructed by the microcomputer at indoor unit that judging the condition according to internal setting temperature and intake air temperature.

9.1.1. Internal Setting Temperature

Once the operation starts, remote control setting temperature will be taken as base value for temperature shifting processes. These shifting processes are depending on the air conditioner settings and the operation environment. The final shifted value will be used as internal setting temperature and it is updated continuously whenever the electrical power is supplied to the unit.

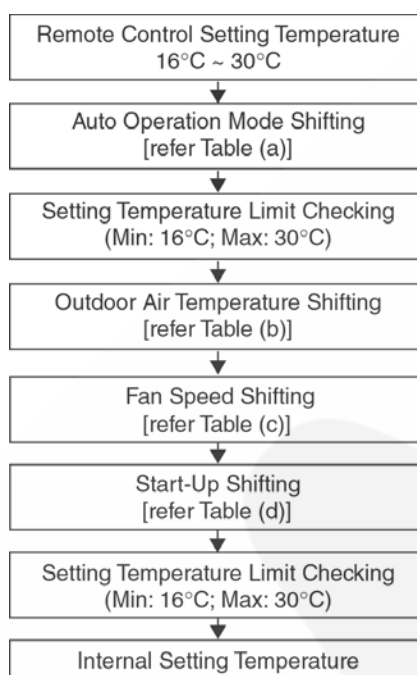

Table (a): Auto Operation Mode Setting

Mode Shift:	Temperature Shift (°C)
Cooling/Dry → Heating	-2.0
Heating → Cooling/Dry	+2.0

Table (b): Outdoor Air Temperature Shifting

Mode:	Outdoor Temperature, X (°C):	Temperature Shift (°C)	
		CS-HE9DKE	CS-HE12DKE
Cooling/Soft Dry	$38 \leq X$	0.00	0.00
	$30 \leq X < 38$	0.00	0.00
	$23 \leq X < 30$	0.00	0.00
	$X < 23$	0.00	0.00
Heating	$21 \leq X$	0.00	0.00
	$17 \leq X < 21$	0.00	0.00
	$9 \leq X < 17$	0.00	0.00
	$5 \leq X < 9$	+0.50	+1.00
	$1 \leq X < 5$	+1.00	+1.25
	$X < 1$	+1.50	+2.00

Table (c): Fan Speed Shifting

Mode:	Fan Speed:	Temperature Shift (°C)
Cooling	All	+1.25
Soft Dry	All	+1.0
Heating	Lo	+1.0
	Hi, Me-, Me, Me+, Auto	+0.25 (CS-HE9DKE) +0.50 (CS-HE12DKE)

Table (d): Start-Up Shifting

Mode within 60 Minutes from Start-up:	Temperature Shift (°C)
Cooling/Soft Dry	-1.0
Heating	+2.0

9.2. Indoor Power Relay Control

The Power Relay turns on under the following conditions.

1. For three minutes, when plugged in the A/C or the Error Reset button on remote controller is pressed.
2. During Installation Check Mode and following for three minutes after checking.
3. During On-timer sampling and during Preliminary operation.
4. During Operation and following for three minutes after the operation is stopped.
5. During Auto Operation, Test run, Forced Heating or Odour Removal Operation and following for three minutes after the operation is stopped.

9.3. Room Temperature Control (Compressor Control)

Operating frequency of a compressor is decided according to temperature differences between remote controller setting and room temperatures. By adding a relative method, based on current frequency, which gives frequency changes, a room temperature is adjusted.

9.3.1. Cooling Operation

9.3.1.1. Thermostat Control

- [Thermostat-ON Temperature] = [Intake Air Temperature] - [Remote Controller Setting Temperature] < -1.5°C
- [Thermostat-ON Temperature] = [Intake Air Temperature after 2 minutes] - [Remote Controller Setting Temperature] < -1.5°C
- When Room Temperature is below Thermostat-OFF Temperature for 3 minutes or more, it turns to Thermostat-OFF.
- The maximum power is applied only for the first 30 minutes of the operation, after that, rated power is applied. If the POWERFUL Switch is pressed during operation, the maximum power will be applied for 30 minutes.

Setting Intake Air Temp. (°C) Thermostat-OFF Temp. -1.5 (°C)	Max. Power Rated Power
	Intermediate Power
	Min. Power
OFF	

Cooling power	CS-HE9DKE	CS-HE12DKE
Maximum power	3.0kW	4.0kW
Rated power	2.6kW	3.5kW
Minimum power	0.6kW	0.6kW

9.3.2. Dry Operation

9.3.2.1. Thermostat Control

- The unit can be operated in the Scrolling Dry Operation by selecting Cooling DRY mode with the DRY button on the remote controller.
- [Thermostat-OFF Temperature] = [Intake Air Temperature] - [Remote Controller Setting Temperature] > -2.0°C
- When Room Temperature exceeds Thermostat-OFF Temperature for 3 minutes or more, it turns to Thermostat-OFF.
- The fan speed setting is selectable. → Five stages manually and one stage automatically (QUIET). (Same as Cooling mode.)

9.3.3. Heating Operation

9.3.3.1. Thermostat Control

- [Thermostat-OFF Temperature] = [Intake Air Temperature] - [Remote Controller Setting Temperature] > +2.0°C
- [Thermostat-ON Temperature] = [Intake Air Temperature after 2 minutes] - [Remote Controller Setting Temperature] < +2.0°C.
- When Room Temperature exceeds Thermostat-OFF Temperature for 3 minutes or more, it turns to Thermostat-OFF.
- When operation in rated power continues for 3 minutes or more, it turns to the maximum power.



Setting Intake Air Temp. (°C) Thermostat-OFF Temp. +2.0 (°C)	OFF
	Min. Power
	Intermediate Power
	Max. Power Rated Power



Cooling power	CS-HE9DKE	CS-HE12DKE
Maximum power	6.5kW	7.7kW
Rated power	3.6kW	4.8kW
Minimum power	0.6kW	0.6kW

9.4. Airflow Direction Control

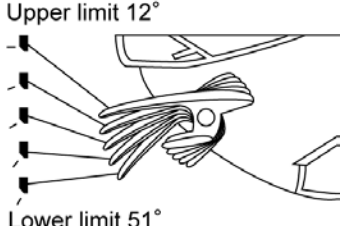

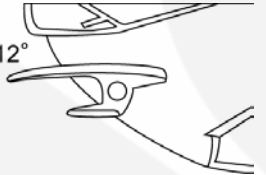

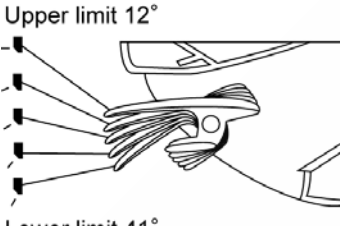
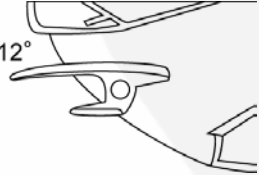

9.4.1. Horizontal and Vertical Directions

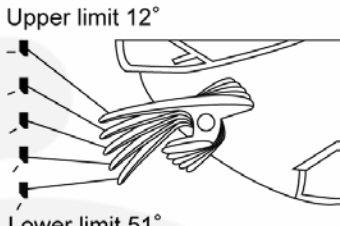
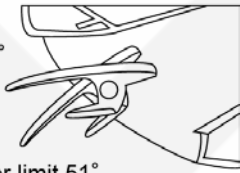
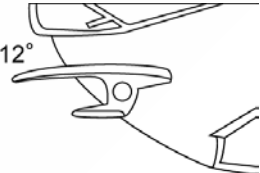
Vertical louver is controlled by remote control: the Vertical Airflow Direction button on the remote controller and by each operation mode, as shown in the table below.

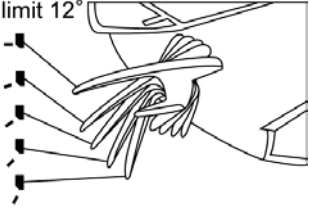
Cooling Operation Mode		
Manual Operation	Vertical Automatic Operation	Powerful-ON
 <p>Upper limit 12°</p> <p>Lower limit 51°</p> <ul style="list-style-type: none"> Five-level setting is possible with the remote controller. 	<p>Swing</p>  <p>Upper limit 12°</p> <p>Lower limit 51°</p> <ul style="list-style-type: none"> The louver swings between the upper limit and the lower limit. 	 <p>26°</p> <ul style="list-style-type: none"> After Powerful is turned on, the louver is fixed at 26° for 5 minutes or until the Neural Control is stabilized.  <p>12°</p> <ul style="list-style-type: none"> After the Neural Control is stabilized, the louver is fixed at 12°.

Dry Operation Mode		
Manual Operation	Vertical Automatic Operation	Power-ON (Automatic Operation)
 <p>Upper limit 12°</p> <p>Lower limit 41°</p> <ul style="list-style-type: none"> Five-level setting is possible with the remote controller. 	 <p>12°</p> <ul style="list-style-type: none"> The louver is fixed at 12°. 	 <p>12°</p> <ul style="list-style-type: none"> The louver is fixed at 12°.

Ion Operation Mode		
Manual Operation	Vertical Automatic Operation	Power-ON (Automatic Operation)
 <p>Upper limit 12°</p> <p>Lower limit 51°</p> <ul style="list-style-type: none"> Five-level setting is possible with the remote controller. 	<p>Swing</p>  <p>Upper limit 12°</p> <p>Lower limit 51°</p> <ul style="list-style-type: none"> The louver swings between the upper limit and the lower limit. 	 <p>12°</p> <ul style="list-style-type: none"> The louver is fixed at 12°.

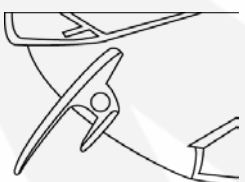
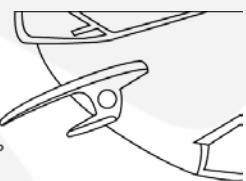
Heating Operation Mode		
Manual Operation	Vertical Automatic Operation	Powerful-ON
<p>Upper limit 12°</p>  <p>Lower limit 66°</p> <ul style="list-style-type: none"> • Five-level setting is possible with the remote controller. 	<p>1. When heat exchanger temperature is less than 32°C.</p>  <p>12°</p> <p>2. When heat exchanger temperature is between 32°C and 56°C.</p>  <p>66° (57°)</p> <p>3. When heat exchanger temperature is 56°C or more.</p>  <p>26°</p>	<p>1. When heat exchanger temperature is less than 32°C.</p>  <p>12°</p> <p>2. Quick Heating Operation</p>  <p>61° (52°)</p> <p>3. Warm Heating Operation</p>  <p>66° (57°)</p> <p>4. When heat exchanger temperature is 56°C or more.</p>  <p>26°</p>

- The vertical louver is closed when the unit is turned off with the remote controller. (Stop position)
- The vertical louver is fully opened and move to the setting position when the unit is turned on with the remote controller.
- The vertical louver remains at open position when the unit is turned off during operation.
- The values in the parentheses () are for the models: CS-HE12DKE.

9.4.2. Horizontal Airflow Direction Control

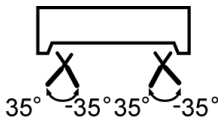
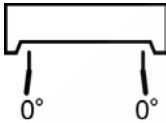
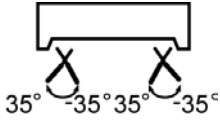
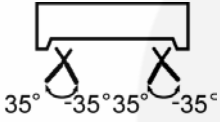
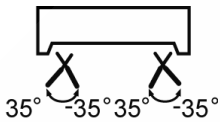
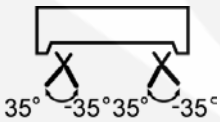
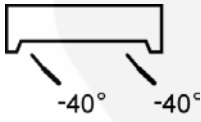
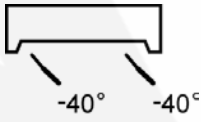
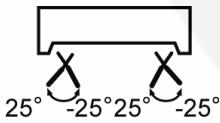
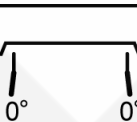
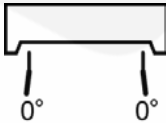
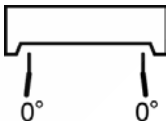
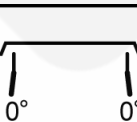
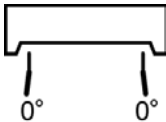
Operation Mode		Horizontal Automatic Operation	Operation for 5 min. after Powerful-ON or the Neural Control is stabilized.
Cooling		 <p>35° -35° 35° -35°</p> <ul style="list-style-type: none"> The louver horizontally swings at a fixed cycle. 	 <p>0° 0°</p>
Dry		 <p>35° -35° 35° -35°</p> <ul style="list-style-type: none"> The louver horizontally swings at a fixed cycle. 	 <p>35° -35° 35° -35°</p> <ul style="list-style-type: none"> The louver horizontally swings at a fixed cycle.
Ion		 <p>35° -35° 35° -35°</p> <ul style="list-style-type: none"> The louver horizontally swings at a fixed cycle. 	 <p>35° -35° 35° -35°</p> <ul style="list-style-type: none"> The louver horizontally swings at a fixed cycle.
Heating	When heat exchanger temperature is below 32°C.	 <p>-40° -40°</p>	 <p>-40° -40°</p>
	When heat exchanger is between 32°C (, incl.) and 56°C (, excl.)	<p>When the Neural Control is stabilized.</p>  <p>25° -25° 25° -25°</p> <ul style="list-style-type: none"> The louver horizontally swings at a fixed cycle. <p>When the Neural Control is not stabilized.</p>  <p>0° 0°</p>	<p>In Quick Warm Operation</p>  <p>0° 0°</p> <p>In Warm Heating Operation</p>  <p>0° 0°</p>
	When heat exchanger temperature is 56°C or more.	 <p>0° 0°</p>	 <p>0° 0°</p>

9.5. Quiet operation (Cooling Mode / Cooling area of Dry Mode)

A. Purpose

To provide quiet cooling operation at limited fan speed which lower than Manual Low Fan Speed. (See 9.6 Fan Motor Operation table.)

- It improves the operation noise approximately 3dB compared to Manual Low Fan Speed.

B. Control condition

a. Quiet operation start condition

- When QUIET button at remote control is pressed.
(QUIET is approved on LED at remote control.)

b. Quiet operation stop condition

- One of the following conditions is satisfied, QUIET operation is to be concealed.
 1. Repressing QUIET button during quiet operation.
 2. Pressing POWERFUL button.
 3. Pressing FAN SPEED button, the operation is to be shifted to the selected fan speed.
 4. Changing the operation mode to IONIZER only operation.
 5. Stopping the operation by OFF/ON button and/or OFF Timer.

9.5.1. Quiet operation under Dry operation (Dry area at Dry Mode)

Automatic Fan Speed (Dry operation)

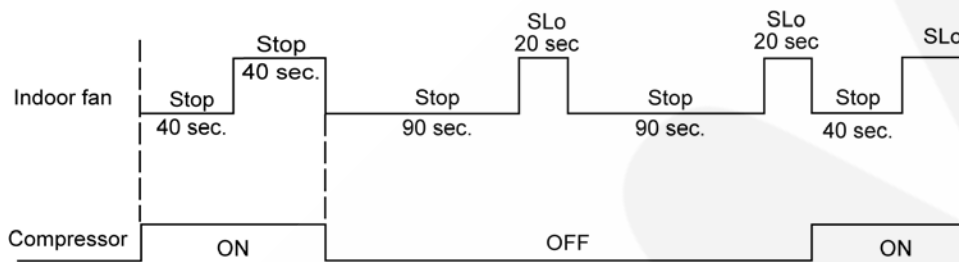

Manual Fan Speed (Dry operation)



9.5.2. Quiet operation (Heating)

A. Purpose

To provide quiet heating operation at limited fan speed which lower than Manual Low Fan Speed. (See 9.6 Fan Motor Operation table.)

- It improves the operation noise approximately 3dB compared to Manual Low Fan Speed.

B. Control condition

a. Quiet operation start condition

- When QUIET button at remote control is pressed.

(QUIET is approved on LED at remote control.)

b. Quiet operation stop condition

- One of the following conditions is satisfied, QUIET operation is to be concealed.

1. Reprising QUIET button during quiet operation.
2. Pressing POWERFUL button.
3. Pressing FAN SPEED button, the operation is to be shifted to the selected fan speed.
4. Changing the operation mode to IONIZER only operation.
5. Stopping the operation by OFF/ON button and/or OFF Timer.

9.6. Indoor Fan Control

9.6.1. Fan Motor Operation

- Fan speed is controlled according to operation conditions such as fan speed setting on the remote controller as shown in the table below.
- There is a different speed control from setting on the remote controller.
- When Dry operation is selected, in the Cooling area, fan speed will be switched to one at Cooling mode and in the Dry area, it will be switched to one at Dry mode.

CS-HE9DKE

		Cooling Sleep Shift															
		SSLo	SLo			Lo-			Lo	Me-		Me		Me+		Hi	SHi
Revolution		440	480	530	540	570	600	610	670	780	810	890	910	1000	1040	1100	1180
Cooling	Manual																
	Automatic		Odour cut								⊙		⊙				
	Powerful																Quick Cooling
	Quiet																
Dry	Manual		⊙														
	Automatic		⊙								⊙		⊙				
	Powerful																Quick Cooling
	Quiet		⊙														
Ion	Manual																
	Automatic		⊙														

		Heating Sleep Shift															
		SSLo	SLo			Lo-			Lo	Me-		Me	Me+		Hi		
Revolution		410	480			680	700		760	780	860	910	960	1010		1160	
Heating	Manual	⊙	⊙			⊙											
	Automatic	⊙	⊙			⊙			⊙								
	Powerful	⊙	⊙			⊙			⊙								
	Quiet	⊙	⊙			⊙	max										

The "⊙" indicates fan speed that is automatically set.
 The "← →" indicates area in which fan speed is changed.
 The "max" indicates the maximum fan speed.

CS-HE12DKE

		Cooling Sleep Shift															
		SSLo	SLo			Lo-			Lo	Me-		Me		Me+		Hi	SHi
Revolution		480	570	610	620	650	680	690	750	840	890	930	990	1020	1060	1120	1220
Cooling	Manual																
	Automatic		Odour cut								⊙		⊙				
	Powerful																Quick Cooling
	Quiet																
Dry	Manual		⊙														
	Automatic		⊙								⊙		⊙				
	Powerful																Quick Cooling
	Quiet		⊙														
Ion	Manual																
	Automatic	⊙															

		Heating Sleep Shift															
		SSLo	SLo			Lo-			Lo	Me-		Me	Me+		Hi		
Revolution		410	530			780	790		880	900	970	1010	1060	1150		1240	
Heating	Manual	⊙	⊙			⊙											
	Automatic	⊙	⊙			⊙			⊙								
	Powerful	⊙	⊙			⊙			⊙								
	Quiet	⊙	⊙			⊙	max										

The "⊙" indicates fan speed that is automatically set.
 The "← →" indicates area in which fan speed is changed.
 The "max" indicates the maximum fan speed.

9.6.2. Cooling Operation

1. Automatic Fan Speed

Odour Cut Control makes fan stop temporarily for 40 seconds at the beginning of unit operation or Thermostat-ON in order to wash away odour ingredients from heat exchanger with dehumidifying water. Fan operation is repeated every 20 seconds at a speed of "SLo" (Refer to the "Indoor Fan Control" chapter.) as the graph shown below.

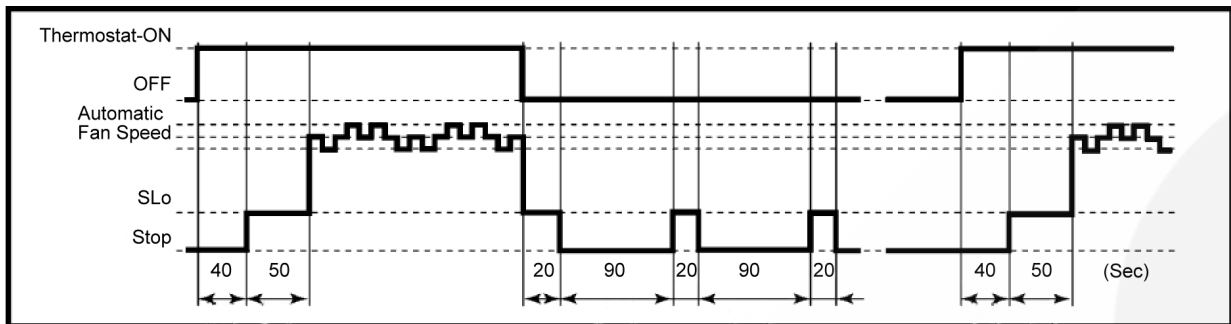

2. Powerful

Unit is automatically operated in Quick Cooling (Fan speed "SHI": Refer to the "Indoor Fan Control" chapter.) in the initial 5 minutes of the operation and after that, switched to Chilly Cooling according to the symmetrical areas.

3. Low noise control

At setting of Fan Speed: "AUTO" (Refer to the "Indoor Fan Control" chapter.), if room temperature reaches a setting temperature, fan speed will be reduced for the fan noise reduction.

4. Dew Condensation Prevention Control

The maximum frequency for Indoor Unit is decided by the Dew Condensation Prevention Control according to elapsed operating times. Condition: Indoor unit fan speed is "Me-" or less.

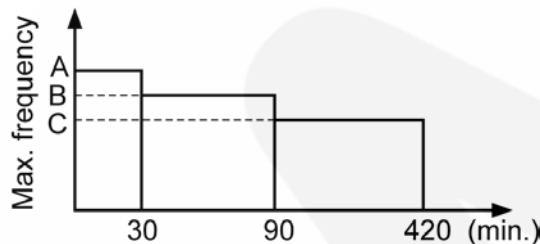

	CS-HE9DKE	CS-HE12DKE
Max. Frequency (A) (Hz)	35	54
Max. Frequency (B) (Hz)	35	42
Max. Frequency (C) (Hz)	30	37

- Conditions resolvable

- When remote controller setting temperature or fan speed setting is changed:
- When 420 minutes elapsed:

5. Forced Cooling Operation

Fan speed will be "Hi" (Refer to the "Indoor Fan Control" chapter.) when the units is operated at Forced operation mode.

9.6.3. Dry Operation

In the cooling mode area, fan speed is the same as cooling operation mode. In the dry mode area, it is switched to "SLo". (Refer to the "Indoor Fan Control" chapter.) In the Thermostat-OFF, fan stops 5.5 minutes and after that, operates at a speed of "SLo" (Refer to the "Indoor Fan Control" chapter.). (At manual fan speed) At automatic fan speed operation, fan operates repeatedly between 90-second stop and 20-second "SLo". At the beginning of unit operation and Thermostat-ON, fan stops 40 seconds.

9.6.4. Heating Operation

1. Hot Start and Cold Draft

At the beginning of unit operation, when indoor heat exchanger temperature is low, fan will be stopped. When the temperature is getting high, the unit will be prevented from Cold Draft by increasing fan speed.

2. Automatic fan speed

At automatic fan speed setting, when the heat exchanger temperature is getting high, the unit will be prevented from Cold draft by increasing fan speed as well as manual fan speed setting. In a fixed fan speed area, fan speed will be controlled to discharge

air having a constant temperature.

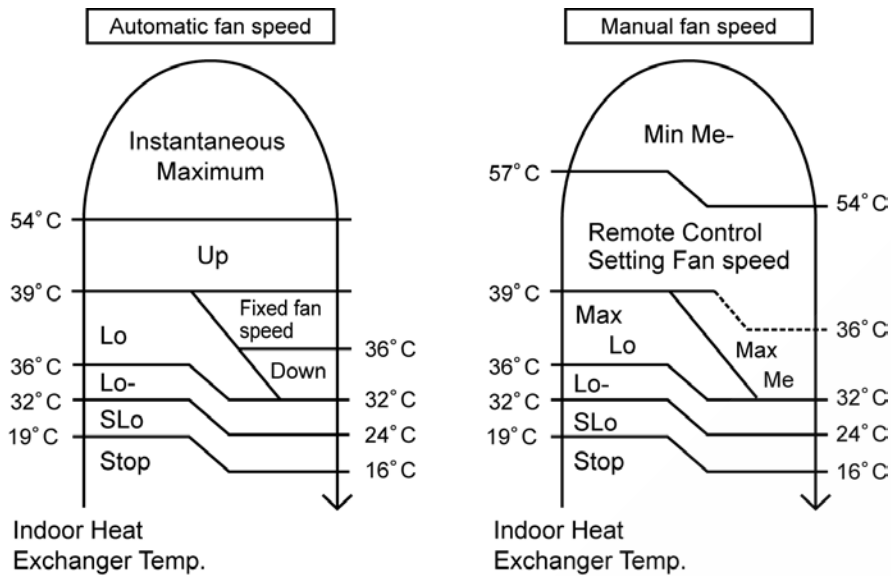

- Refer to the “Indoor Fan Control” chapter for fan speed of each model.

3. Thermostat-OFF

In thermostat-OFF, fan will operate repeatedly between the speeds of “SLo” for 20 second and “SSLo” for 100 seconds. (Refer to the “Indoor Fan Control” chapter.)

4. Forced Heating Operation

In Forced Heating mode operation, fan speed is “Hi”. (Refer to the “Indoor Fan Control” chapter.)

9.7. Powerful Operation

If the POWERFUL button is pressed during operating in Cooling, Heating, Dry or AUTO, the unit always forces to operate in respective modes (Quick Cooling, Quick Heating and Dry) for 5 minutes, which fan speed is "SHI" even though unit is in each stable area.

9.7.1. Cooling Operation

- Airflow direction, Fan speed and Setting temperature are optimized.
- “[Intake Air temperature] - [Remote controller setting temperature]” is detected every 30 seconds by indication from indoor unit and controlled to each area.

Quick Cooling → Unit forcibly turns to Quick Cooling operation for 5 minutes after Powerful-ON even through it is in the Chilly Cooling area. Chilly Cooling → Discharge air temperature is kept low by changing fan speed according to room temperature and chilly feeling will be produced.

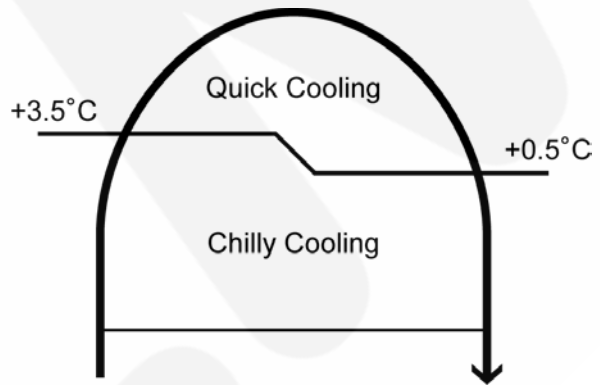

9.7.2. Dry Operation

- Airflow direction, Fan speed and Setting temperature are optimized.
- “[Intake air temperature] - [Remote controller setting temperature]” is detected every 30 seconds by indication from indoor unit and controlled to each area.

Quick Cooling → Unit forcibly turns to Quick Cooling operation for 5 minutes after powerful-ON even through it is in the Chilly Air Cooling area. Chilly Cooling → Discharge air temperature is kept low by changing fan speed according to room temperature and chilly feeling will be produced.

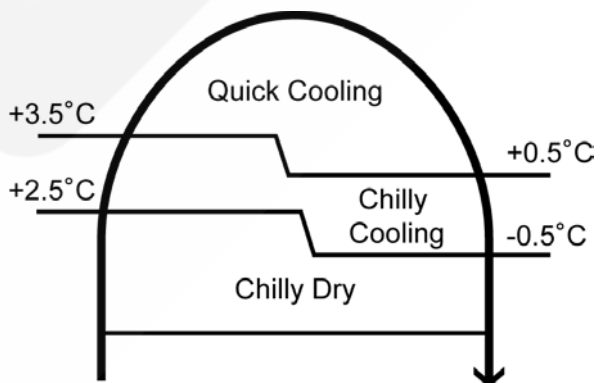

9.7.3. Heating Operation

- Airflow direction, Fan speed and Setting temperature are optimized.
- “[Intake Air temperature] - [Remote controller setting temperature]” is detected every 30 seconds by indication from indoor unit and controlled to each area.

Quick Heating → Unit forcibly turns to Quick Heating operation for 5 minutes after Powerful-ON even through it is in the Warm Heating area. Warm Heating → Discharge air temperature is kept high by changing fan speed according to room temperature and warm feeling will be produced.

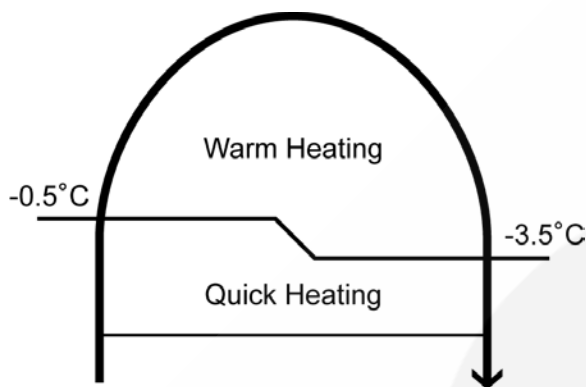

9.8. Automatic Operation

- Operation mode (Cooling, Dry and Heating) is automatically selected.
- Operation mode is selected at the beginning of unit operation and every 30 minutes. Temperature, fan speed and airflow direction are set with the remote controller.
- During cooling mode operation, if Dry mode is selected in next operation mode selection, the operation will be Cooling Dry.

9.8.1. Operation Mode Selection

Operation mode is selected according to outdoor air temperature, intake air temperature and setting temperature.

1. "Heating" is selected when outdoor air temperature is below 16°C.
2. "Cooling" is selected when intake air temperature is 25°C or more. (But, when intake air temperature is 16°C or more.)
3. When outdoor air temperature is below 25°C, if remote controller setting temperature is increased, selectable range of "Heating", if decreased, selectable range of "Heating" will be extended respectively.

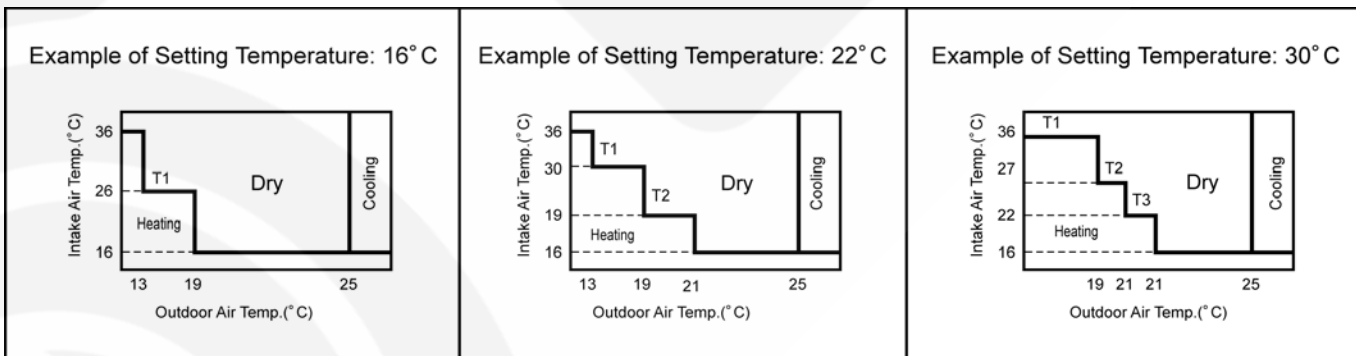
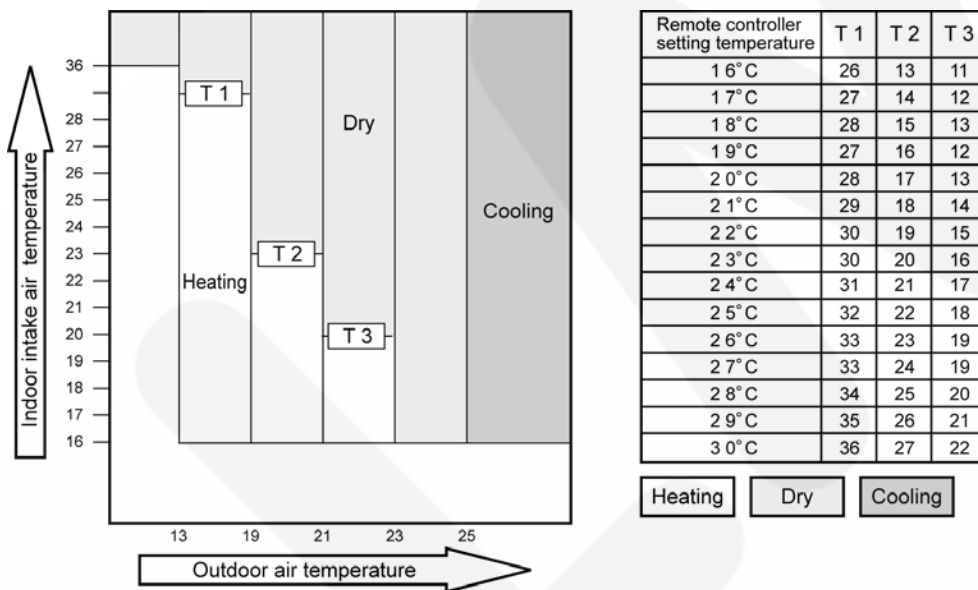

9.9. Sleep Timer Operation

- Sleep timer setting with the remote controller makes the unit automatically turn off on the off-set times (0.5, 1, 2, 3, 5 and 7 hours). Remained time shows every one hour on a display of the remote controller. Remained time disappears when time is up.
- In 5- and 7-hour sleep timer settings, "Sleep Shift Control" functions in and after 3 hours.
- Sleep Shift Control in Cooling Operation
 - Indoor fan speed is set to "Lo". (Refer to the "Indoor Fan Control" chapter for each model.)
 - A setting temperature is increased by 1°C.
- Sleep Shift Control in Dry Operation
 - Indoor fan speed is set to "SLo". (Refer to the "Indoor Fan Control" chapter for each model.)
 - A setting temperature is increased by 1°C.
- Sleep Shift Control in Heating Operation
 - Indoor fan speed is set to "Lo-". (Refer to the "Indoor Fan Control" chapter for each model.)
 - A setting temperature is decreased by 1°C.

9.10. Timer Operation

On Timer

- According to air-conditioning load, preliminary operation is performed to be a set temperature on set time. Preliminary operation time is as shown in the table on the right.
- Indoor and outdoor fans operate for 30 seconds in 70 minutes before a set time, and outdoor and intake air temperatures are detected.
- Airflow direction in preliminary operation is followed by remote controller setting. (Same condition as in normal operation.) Fan speed in preliminary operation is as shown in the table on the right.
- In preliminary operation, deicing judgment is performed after heating operated for 15 minutes in 50 minutes before set ON-time. This is because it makes start-up time short when outdoor air temperature is extremely low in midwinter.

Preliminary operation in Cooling or Dry operation

Outdoor Air Temperature	Intake Air Temperature	Preliminary Operation Starting Time
35°C or more	—	Before 15 min.
—	35°C or more	Before 15 min.
30 - 35°C	25 - 30°C	Before 10 min.
Below 30°C	Below 25°C	Before 5 min.

Preliminary operation in Heating operation

Outdoor Air Temperature	Intake Air Temperature	Preliminary Operation Starting Time
5°C or more	—	Before 40 min.
—	15 °C or more	Before 40 min.
0 - 5°C	5 - 15°C	Before 45 min.
Below 0°C	Below 5°C	Before 50 min.

Fan speed in Preliminary operation

Operation mode	Cooling, Cooling Dry	Heating
Manual speed	Selected fan speed	Selected fan speed
Automatic speed	Up to Lo	Up to Lo

<Example of ON-timer Operation>

Conditions:

1. Outdoor air temperature: Below 0 °C
2. Intake air temperature: Below 5 °C
3. Heating mode operation setting

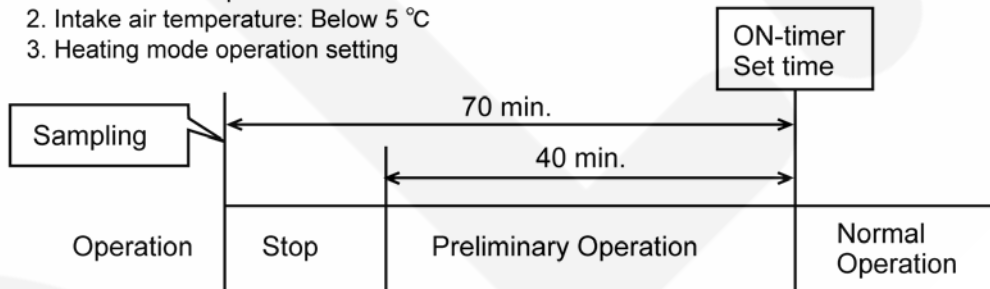

9.11. Auto Restart Control

1. When the power supply is cut off during the operation of air conditioner, the compressor will re-operate within three to four minutes (there are 10 patterns between 2 minutes 58 seconds and 3 minutes 52 seconds to be selected randomly) after power supply resumes.
2. This type of control is not applicable during ON/OFF Timer setting.

9.12. Ionizer Operation

Single Ionizer Operation

- The unit turns to single ionizer operation mode by pressing the ION button on the remote controller at stop mode and the ION LED (Green) on the main unit will light up.
- * Temperature setting is not possible during the operation.

Simultaneous Ionizer Operation (Heating, Cooling, Dry and Auto)

- The unit turns simultaneous ionizer operation mode by pressing the ION button on the remote controller at each operation mode (Heating, Cooling, Dry and Auto) and the ION LED (Green) on the main unit will light up. The LED will be off by pressing the button again, but the unit remains the operation.
- * To stop all the operations, press the OFF/ON button on the remote controller.

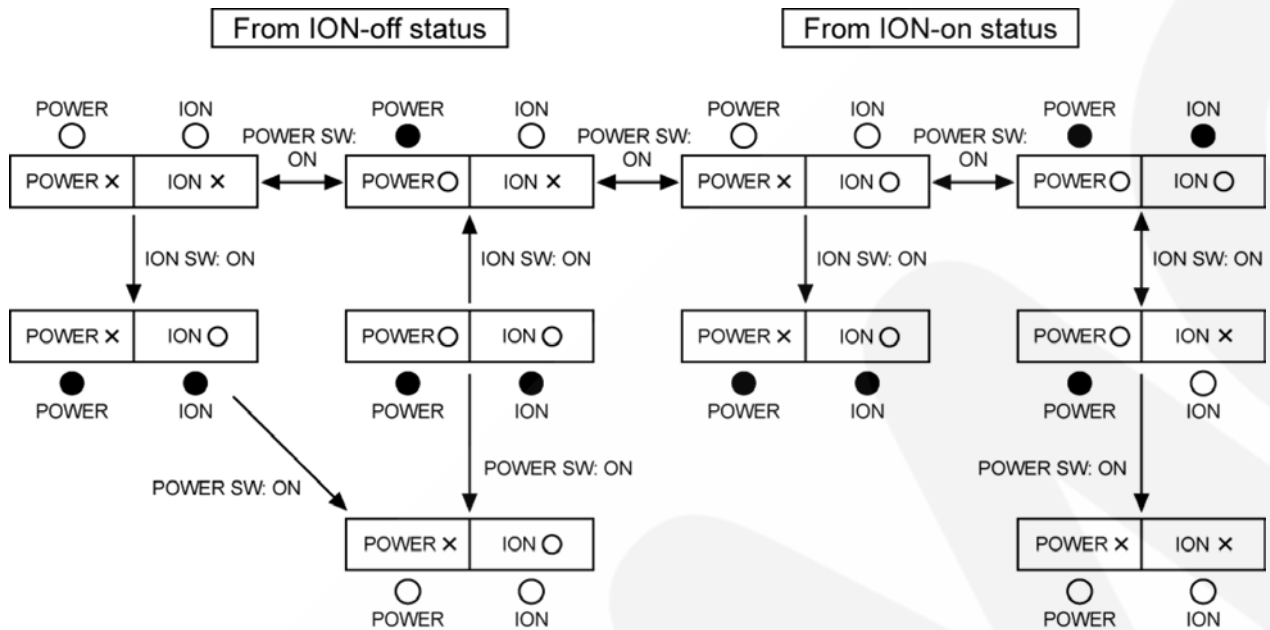

Single blinking of the ION LED does not indicate Breakdown.

When unit was operated under the condition that a discharge insulation of the Ion generator is deteriorated (Dust, Attached water, etc.):

If the insulation deterioration of the unit discharge part is big;

Insulation deterioration will be detected in and after 2 seconds from the unit operation starting, and the unit will turn off for 30 minutes and turn on again. When this operation is repeated 24 times, the ION LED will start blinking. But, if the unit operation is stopped or the Ionizer is operated properly for 10 minutes, the count will be cleared.

Condition resoluteive

It can be canceled by stopping the operation during the ION LED blinking.

9.13. Oxygen Enrich Operation

9.13.1. Oxygen Enrich System Figure

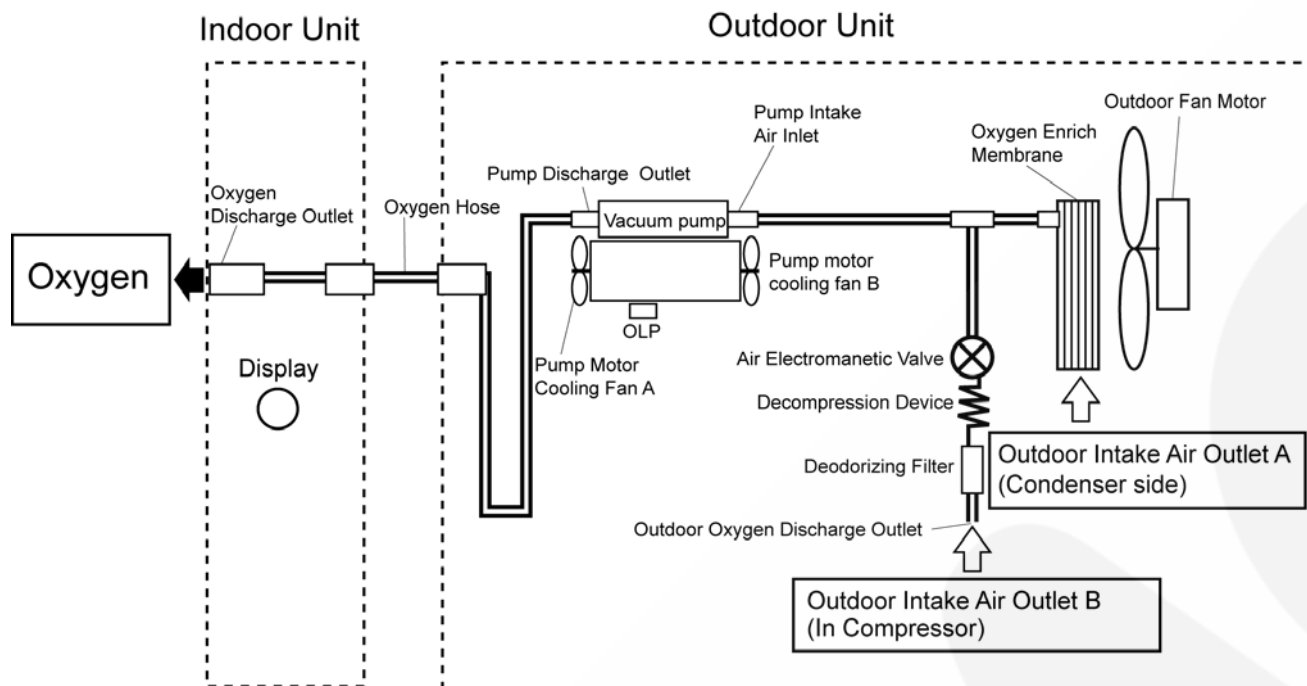

9.13.2. Indoor Fan Control

Single Oxygen Enrich operation

1. Manual fan speed Not available for the remote controller.
2. Automatic fan speed Fixed.

	Revolution (rpm)
Normal Fan Speed (AUTO)	480

- When used in common with other modes, it will be followed by other modes.
Order of priority: Cooling, Dry and Heating > Ion > Oxygen Enrich
- Powerful and Quiet operations are not accepted at the Oxygen Enrich Operation mode.

9.13.3. Indoor Airflow Direction Control

1. Manual and Automatic Airflow Direction Same as Cooling operation.
 - When used in common with other modes, it will be followed by other modes.
Order of priority: Cooling, Dry and Heating > Ion > Oxygen Enrich

9.13.4. Conditions of starting and cancellation

1. ON/OFF by the "Oxygen & Ventilation Selection" Switch on the remote controller
 - When "Oxygen" is selected with the Switch under a condition of Ionizing Air Clearing OFF
→ Single Oxygen Enrich Operation
 - When "Oxygen" is selected with the Switch under a condition of Ionizing Air Clearing ON,
→ Ionizing Air Clearing + Simultaneous Oxygen Enrich Operation
 - When "Oxygen" is selected with the Switch during Single Oxygen Enrich Operation,
→ Operation is stopped.
 - When "Oxygen" is selected with the Switch during Cooling, Heating, Dry or Ionizing Air Clearing Operation,
→ Cooling, Heating, Dry or Ionizing Air Clearing Operation + Simultaneous Oxygen Enrich Operation,
 - When "Oxygen" is selected with the Switch during Cooling, Heating, Dry or Ionizing Air Clearing Operation + Simultaneous Oxygen Enrich Operation,

→ Cooling, Heating, Dry or Ionizing Air Cleaning Operation

- When "Oxygen" is selected with the Switch during Ionizing Air Cleaning Operation + Simultaneous Oxygen Enrich Operation,
→ Ionizing Air Cleaning Operation

2. Common use with ON/OFF Timer

- When ON-Time of the Timer setting is up during operation stop,
→ In last time operation, if unit is stopped in Single Oxygen Enrich Operation, it operates in Single Oxygen Enrich mode. → In last time operation, if unit is stopped in operations other than Single Oxygen Enrich, it operates at its operation mode.
- When ON-Time of the Timer setting is up during Oxygen Enrich Operation,
→ Unit remains the operation.
- When OFF-Time of the Timer setting is up during Oxygen Enrich Operation,
→ Unit stops operating.
- Preliminary Operation of Single Oxygen Enrich Operation
→ Not applicable.

9.13.5. Oxygen Monitor Display

Monitor level	0	1	2	3
Status	Stop	Stop (Vacuum pump operation)	—	In operation
LED Display	OFF	Blinking	—	ON
Oxygen requirement level	0	0	—	3

- Monitor level when installation (Oxygen) is checked is "3".

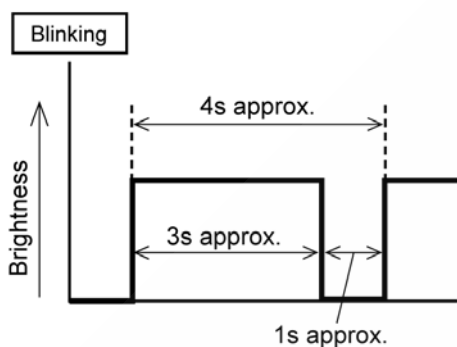

9.13.6. Oxygen Enrich Control

- Vacuum pump is operated after Oxygen requirement level that is decided in outdoor unit from Oxygen supply level decided in indoor unit and protective control devices such as a vacuum pump.

Oxygen Requirement Level	Oxygen Supply Level	Vacuum pump operation time	
		OFF-time (min.)	ON-time (min.)
0	0	10	0
—	1	7	3
—	2	4	6
3	3	0	10

- Operating cycle period of Vacuum pump: 10 minutes; Oxygen supply level is renewed in a cycle.

9.13.7. Installation (Oxygen) Check Control

- For operation check at installation and breakdown self-diagnosis, continuous operation of 2-way valve and vacuum pump is conducted by checking installation from indoor room.

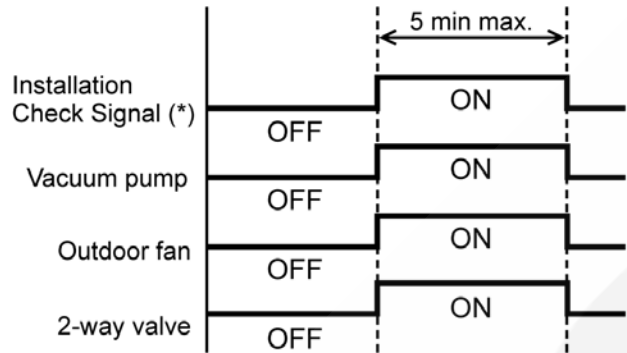

Note (*)

How to turn the signal on.

1. Press the AUTO button continuously for 11 seconds. (Receiving sound: 3 beeps will be heard from the main unit.)
2. Release the button after hearing the beep sound and press the RESET button on the main unit. (Receiving sound: 1 beep will be heard from the main unit.)

9.14. Deice Control <Heating>

- Degree of frosting is expected by operation time, heat exchanger temperature and outdoor air temperature.
- According to frosting conditions, deicing operation is effectively performed.

1. Timer for deice control will function when outdoor heat exchanger temperature after continuous 40 minutes heating operation is below the primary judgment temperature. When the timer reaches 20 minutes or heat exchanger temperature is below the secondary judgment temperature, deicing operation will start.
2. Four-way valve is switched and deicing is performed by cooling cycle.
3. Deicing will be stopped when 12 minutes elapsed from starting of the operation or heat exchanger temperature reaches 17°C or more.

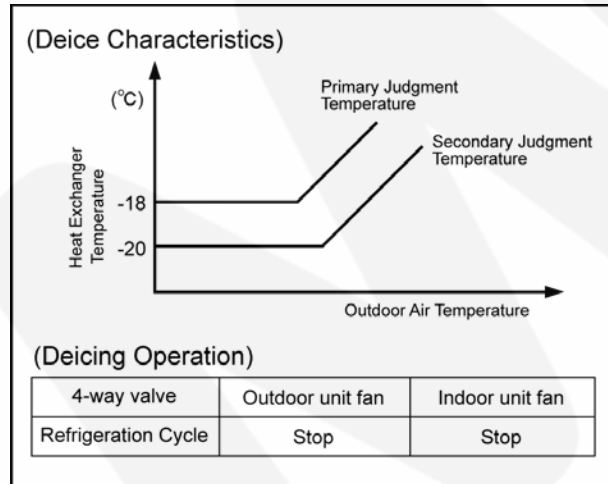

9.15. Protection Control

9.15.1. Time Delay Safety Control

- Compressor will not start for two minutes after stop of the operation.

9.15.2. 30 Seconds Forced Operation

- Once compressor starts the operation, it will not stop its operation for 30 seconds. However, it can be stopped with the remote controller or the Auto button on the indoor unit.

9.15.3. Total Running Current Control

- When the total running current exceeds I1, compressor operation frequency is reduced. If it reaches below I1, the operation frequency is increased. (But, up to programmed frequency.)
- If total running current exceeds I2, compressor is stopped immediately.
- If it happens three (3) times within 20 minutes, operation will be stopped and Timer LED blinks. ("F98" is activating.)

	Running current	CS-HE9DKE	CS-HE12DKE
Cooling	I1	4.5A	5.8A
	I2	12.5A	12.5A
Heating	I1	7.2A	9.6A
	I2	12.5A	12.5A

9.15.4. IPM (Power transistor) Protection Control (DC Peak detection)

Abnormal Current Control

- If inverter load current (DC peak) exceeds a rated value, compressor will be stopped immediately. When the excess occurs within 30 seconds after operation, it restarts in 1 minute and when after 30 seconds, restarts in 2 minutes.
- If the excess continuously occurs 7 times within 30 minutes after compressor starts, the unit will be stopped and timer lamp on the indoor unit will be blinking. ("F99" is to be confirmed.)

IPM Overheating Prevention Control

- If temperature of IPM exceeds 103°C, compressor will be stopped. It will restart in 2 minutes. Temperature for restarting: 90°C.
- If the excess occurs 4 times within 30 minutes after compressor starts, the compressor will be stopped and timer lamp on the indoor unit will be blinking. ("F96" is to be confirmed.)

9.15.5. Compressor Overheating Prevention Control

- If discharge pipe temperature exceeds 100°C, compressor power will be limited.
- If discharge pipe temperature exceeds 112°C, compressor will be stopped.
- If the above excess occurs 4 times per 10 minutes, timer lamp will be blinking. ("F97" is to be confirmed.)

9.15.6. Outdoor High Pressure Prevention Control (Cooling and Dry operations)

- If outdoor heat exchanger temperature exceeds 63°C in cooling or dry operation, compressor will be stopped.
- Timer lamp is not blinking. ("F95" is memorized, then.)

9.15.7. Compressor Protection Control (Refrigeration Cycle Abnormality)

In Cooling and Dry operations

- When compressor is operated continuously for 5 minutes in the maximum cooling power: a running current of 0.6 - 1.2A (excl.) and "[Indoor intake air temperature] - [Indoor heat exchanger temperature]" < 4°C, compressor will be stopped.
- If the above excess occurs twice for 20 minutes, timer lamp is to be blinking. ("F91" is to be confirmed.)

In Heating operation

- When compressor is operated continuously for 5 minutes in the rated heating power: a running current of 0.6 - 1.2A (excl.) and "[Indoor heat exchanger temperature] - [Indoor intake air temperature]" < 5°C, compressor will be stopped.
- If the above excess occurs twice for 20 minutes, timer lamp is to be blinking. ("F91" is to be confirmed.)

9.15.8. Four-way valve Operation Detection Control (Switching Abnormality between Cooling and Heating)

In Cooling operation

1. When indoor heat exchanger temperature exceeds 45°C in 4 minutes after compressor starts, compressor will be stopped.
2. If the above excess occurs 4 times per 30 minutes, timer lamp is to be blinking. ("F11" is to be confirmed.)

In Heating operation

1. When indoor heat exchanger temperature is below 0°C in 4 minutes after compressor starts, compressor will be stopped.
2. If the above excess occurs 4 times per 30 minutes, timer lamp is to be blinking. ("F11" is to be confirmed.)

9.15.9. Anti-Freezing Control (Cooling and Dry operations)

Limit of Cooling power

1. When temperature of indoor heat exchanger is below 5°C, operating frequency will be decreased.
2. When temperature of indoor heat exchanger exceeds 7°C, operating frequency will be increased. (But, up to programmed frequency.)
3. When temperature of indoor heat exchanger is below 0°C continuously for 6 minutes, compressor will be stopped.
4. Timer lamp is not blinking. ("F99" is memorized, then.)

Limit of Indoor fan speed

- When temperature of indoor heat exchanger is below 6°C (2°C at Dry) continuously for 6 minutes, indoor fan speed will be increased by 50 rpm.

9.15.10. Outdoor Air Temperature Control

In Cooling and Dry operations

1. When outdoor air temperature is below 25°C, the maximum power will be limited up to about 80-100% of the rated power.
2. When outdoor air temperature is below 18°C, the maximum power will be limited up to about 50-100% of the rated power.
3. When outdoor air temperature is below 11°C, the maximum power will be limited up to about 26-81% of the rated power.

9.15.11. Indoor Intake Air Temperature Control (Heating operation)

1. When indoor air temperature is 35°C or more, the maximum power will be limited up to the rated power.
2. When fan speed is set at "Lo" and intake air temperature is below 21°C, the maximum power will be limited up to the rated power.

10 Operating Instructions

■ Definition

To prevent personal injury, injury to others and property damage, the following instructions must be followed.

Incorrect operation due to failure to follow instructions will cause harm or damage, the seriousness of which is classified as below:



Warning

This sign warns of death or serious injury.



Caution

This sign warns of injury or damage to property.

The instructions to be followed are classified by the following symbols:



This symbol denotes an action that is PROHIBITED.



These symbols denote actions that are COMPULSORY.

Thank you for purchasing Panasonic Air Conditioner

SAFETY PRECAUTIONS

Installation Precautions



Warning

Do not install, remove and reinstall the unit by yourself.

- Improper installation will cause leakage, electric shock or fire. Please consult an authorized dealer or specialist for the installation work.

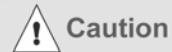

Caution

- This air conditioner must be earthed. Improper grounding will cause electric shock.
- Ensure that the drainage piping is connected properly. Otherwise, water will leak.
- Current leakage protection equipment must be installed. Otherwise, electric shock or fire may occur.
- Do not install the unit in a potentially explosive atmosphere.

Operation Precautions



Warning

- Do not share power outlet.
- Do not modify power cord.
- Do not use an extension cord.
- Do not operate with wet hands.
- Do not operate or stop the unit by inserting or pulling out the power plug.
- Do not insert finger or other objects into the indoor or outdoor unit.
- Do not attempt to repair the unit by yourself.
- Do not use rechargeable (Ni-Cd) batteries.
- Keep the remote control away from infants and small children to prevent them from accidentally swallowing the batteries.
- Insert the power plug properly.
- Use specified supply cord.
- If the supply cord is damaged or needed to be replaced, it must be replaced by the manufacturer or its service agent or a similarly qualified person in order to avoid a hazard.
- Remove the batteries if the unit is not going to be used for a long period of time.
- New batteries of the same type must be inserted following the polarity stated to prevent malfunction of the remote control.



- In case of emergency or abnormal condition (burnt smell, etc) occurs, turn off the power supply and unplug.

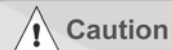

Caution

- Do not pull the cord to disconnect the plug.
- Do not wash the unit with water, benzene, thinner or scouring powder.
- Do not use for other purposes such as preservation of food.
- Do not use any combustible equipment at airflow direction.
- Do not sit or place anything on the indoor or outdoor unit.
- Do not expose directly to cold air for a long period.
- Ventilate the room regularly.
- Pay attention as to whether the installation rack is damaged after long period of usage.
- Switch off the power supply and unplug before cleaning or servicing.
- Turn off the power supply and unplug if the unit is not used for a long period of time.

Safety Regulation

The appliance is not intended for use by young children or infirm person without supervision. Young children should be supervised to ensure that they do not play with the appliance.

Replacement or installation of power plugs shall be performed by authorized/qualified personnel only. The wires in this mains lead are coloured in accordance with the following code:

Terminals	wires	colours (GB Standard)
L	live	brown
N	neutral	blue
E	earth	green-yellow

Different countries may have different colour coding for the wires.

Operation Condition (°C)

Use this air conditioner under the following temperature range.

DBT: Dry Bulb Temperature WBT: Wet Bulb Temperature	Indoor		Outdoor	
	DBT	WBT	DBT	WBT
Maximum Temperature (COOL)	32	23	43	26
Maximum Temperature (HEAT)	30	-	24	18
Minimum Temperature (COOL)	16	11	16	11
Minimum Temperature (HEAT)	16	-	-10	-11

Note: The illustrations in this manual are for explanation purposes only and may differ from the actual unit. It is subjected to change without notice for future improvement.

PRODUCT OVERVIEW

Indoor Unit

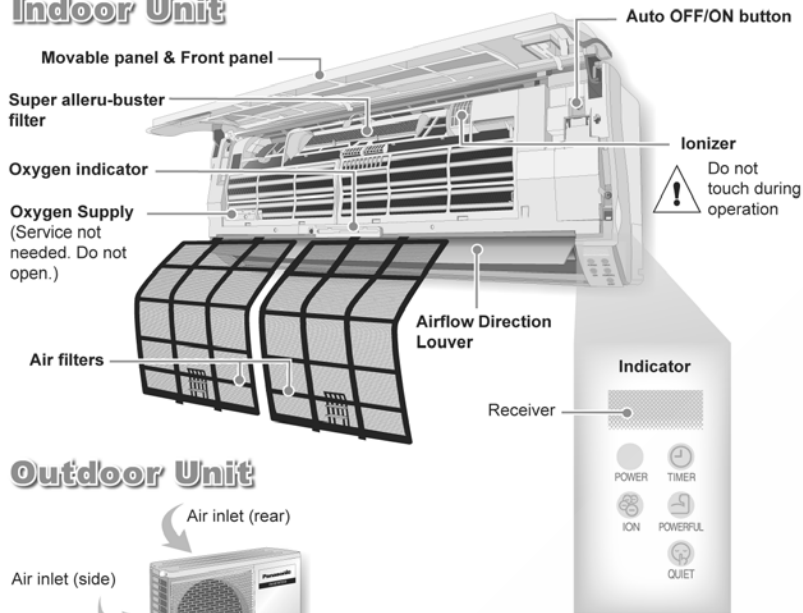

Outdoor Unit

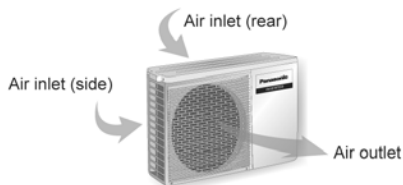

Remote Control

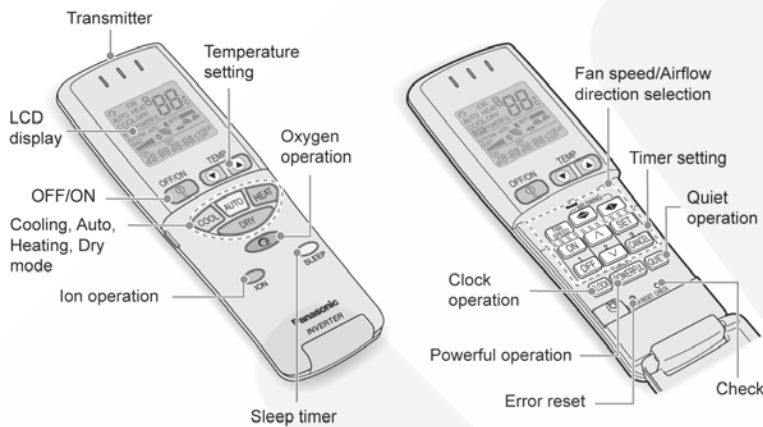

About

Remote Control Preparation

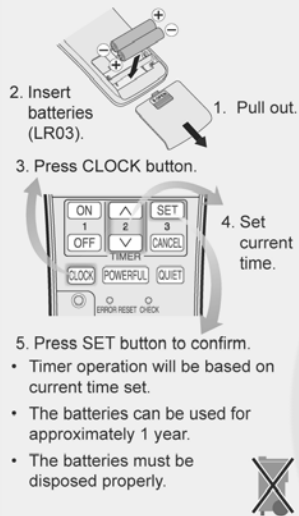

Remote Control Signal

- Make sure it is not obstructed.
- Maximum distance is 8m.
- Certain fluorescent lights may interfere with signal transmission. Consult your dealer.

Auto OFF/ON Button

- To operate the unit if the remote control is misplaced or malfunctioning.

Action	Operation mode
Press once.	Automatic Operation
Press until "beep" sound and release.	*Cooling Operation
Press until "beep" sound and release. Press again until "beep-beep" sound and release.	*Heating Operation

- To OFF, press again the Auto OFF/ON button.
- *The usage of this button is not recommended.



Hints

- If you wish to have the cool air blowing directly on you, set the airflow direction downward but not for an excessive length of time, as it may harm your health.
- It is possible to dim the brightness of the indicators by pressing the [SET] button for 5 seconds. Repeat the process to return to default brightness.



Troubleshooting

- Mist emerges from indoor unit.
 - Condensation effect due to cooling process.
- Remote control/display does not work.
 - Check whether batteries are correctly inserted or need replacement.
- The unit cannot operate.
 - Check either circuit breaker is tripped, power plug is inserted correctly or timer is used correctly.
 - Ensure "OFF" indicator does not shown on remote control.
- Outdoor unit emits water/steam.
 - Condensation or evaporation happens at piping surface.

■ About

MOVABLE PANEL

- Opens for air intake when operation starts, and closes when operation stops. During this time, do not hold it as it may cause malfunction or breakdown.

■ Operation Details

COOL - Cooling Operation

- Enables you to enjoy the cooling effect at your preferred setting temperature.

AUTO - Automatic Operation

- The unit will automatically select the operation mode according to the setting, outdoor and room temperature. During operation mode selection, power indicator blinks. For every 30 minutes, the operation mode is reselected.

HEAT - Heating Operation

- Enables you to enjoy the warming effect at your preferred setting temperature.
- For cold air prevention, air might not blow out immediately and power indicator blinks when operation starts.
- Also operates in defrost mode (maximum 12 minutes) where by the power indicator blinks. The melted frost is drained at outdoor unit and indoor/outdoor fan is stopped.

DRY - Dry Operation

- Enables you to set the desired temperature at low fan speed which provides you with the dehumidifying surroundings.

HOW TO OPERATE

Cool, Auto, Heat, Dry



- Quiet, Powerful, Ion and Oxygen operations could be activated in all operation modes.
- Press  button to stop / start the selected operation.

Hints



- To save electricity, close the curtains when using air conditioner to prevent sunlight and heat from coming in.
- Approximately 10% of electricity can be saved if you set the temperature 1°C higher in cooling operation or 2°C lower in heating operation than the desired temperature.

Troubleshooting



- | | |
|--|---|
| ● Operation delayed for a few minutes after restart. | ➤ This is a normal self protection control. |
| ● Sounds like water flowing during operation. | ➤ Caused by refrigerant flow inside. |
| ● Noise during operations. | ➤ Installation work could be slanted or front panel didn't open properly. |
| ● Cracking sound can be heard during operations. | ➤ Panel expanding/contracting due to change in temperature. |

HOW TO OPERATE

Oxygen, Ion, Powerful, Quiet, Fan Speed, Air Swing

ION

Enables ion operation.

OXYGEN

Enables oxygen operation.

FAN SPEED

Select fan speed.

AIR SWING

Adjust the vertical or horizontal airflow direction louver.

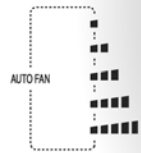

POWERFUL

Enables powerful operation.

QUIET

Enables quiet operation.

- Powerful and Quiet operations could not be activated at the same time.
- Oxygen, Ion, Powerful and Quiet operations could be cancelled by pressing the respective button again.

Operation Details

OXYGEN

- Enriches oxygen content in fresh air.
- Oxygen operation could be activated independently. Press  button to stop the operation.
- When the oxygen operation is stopped, the oxygen indicator would blink (maximum 5 minutes) to sustain the oxygen function.

ION

- To provide fresh air effect by producing negative ions.
- Ion operation could be activated independently. Press  button to stop the operation.
- During Ionizer only operation, Quiet and Powerful could not be activated.

POWERFUL

- To cool down / warm up the room faster.

QUIET

- To provide a quiet environment.

FAN SPEED

- To provide you with the various fan speed selections.
- There are 5 levels of fan speed in addition to automatic fan speed.
- Automatic fan speed:
The speed of the indoor fan is automatically adjusted according to the operation.

AIR SWING

- ◆
• To change airflow direction.
- There are 5 selections in addition to automatic vertical airflow direction.
- If automatic vertical airflow direction has been set, the louver swings up and down automatically.
- ◀▶
• To change airflow direction.
- There are 5 selections in addition to automatic horizontal airflow direction.
- If automatic horizontal airflow direction has been set, the louver swings left and right automatically.
- Please do not adjust the vertical and horizontal airflow direction louver manually.



Hint

- It is possible to turn off/on the oxygen indicator by pressing  for 5 seconds without affecting the oxygen function.



Troubleshooting

- ION indicator on the indoor unit is blinking.
 - Please check if the front panel is closed properly. Clean the ionizer with cotton bud.
- The room has a peculiar odour.
 - This may be a damp smell emitted by the wall, carpet, furniture or clothing in the room.
- Indoor fan stops occasionally during Automatic Fan Speed setting.
 - This is an advanced feature that helps to remove smell from the surrounding area during operation.

■ Operation Details

SLEEP TIMER

- Enables you to select the pre-set timer. It automatically stops after the selected scheduled time.
- When selection is 5 or 7 hours, the setting temperature changes after 3 hours :

Cooling • Dry	↑ 1°C
Heating	↓ 1°C

TIMER

- Use the ON timer to turn on the air conditioner at the desired time. This will give you a cooling or warming environment, e.g. when you return from work or wake up.
- When the ON timer is set, operation will start maximum 50 minutes earlier before the actual set time.
- Use the OFF timer to stop the air conditioner operation at the desired time. This can save electricity while you are going out or sleeping.
- The set timer will repeat daily once it is set.
- If there is a power failure, press the SET button to restore the previous setting once the power is resumed.
- If the timer is cancelled, you can restore the previous setting by pressing the SET button.
- When used together with the Sleep Timer, the Sleep Timer is given priority.

CHECK

- Where there is error, the unit stops its operation and timer indicator blinks.

1. Press for 5 seconds.



2. Browse for respective error code, where "beep" sounds are heard.



3. Turn off the power supply and call authorized distributor.
4. Press "CHECK" button for 5 seconds/ wait 30 seconds to quit checking.

ERROR RESET

Press the "ERROR RESET" button to stop the Timer indicator from blinking. Unit might be operated with limited function depending on error found. (Operation starts, 4 "beep" sounds are heard.)

HOW TO OPERATE

Sleep Timer



SLEEP TIMER

Enables sleep timer.

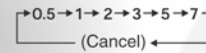

Timer

1

Select ON or OFF timer.

2

Set the desired time.

3

Confirm the setting.



CANCEL

Cancel the selected timer.

- Ensure the clock on the remote control has been set correctly.
- You could use the ON and OFF timers at the same time.
- To cancel either the ON or OFF timer, press **ON** or **OFF**, then press **CANCEL**.

Hint

- For your convenience, you could set the air conditioner to operate automatically by using both ON and OFF timer.

Troubleshooting

- **TIMER** indicator always on.
 - Timer is activated and the setting will repeat itself daily.
- **POWER** indicator is blinking 70 minutes before ON timer is activated.
 - The unit is determining the operation mode by sensing the indoor/outdoor temperature. This happens when it has been set to AUTO operation mode.

CARE & CLEANING



Switch off the power supply before cleaning

1. FRONT PANEL & MOVABLE PANEL

Raise and pull to remove.
Wash gently and dry.

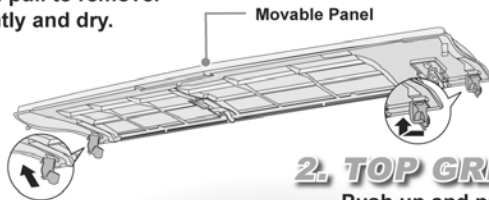

2. TOP GRILL

Push up and pull to remove.
Wash gently and dry.

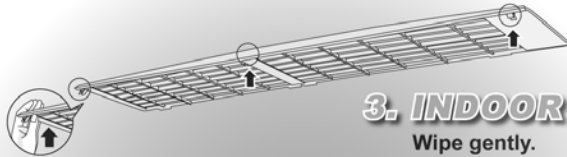

3. INDOOR UNIT

Wipe gently.

4. AIR FILTERS

Vacuum, wash and dry.

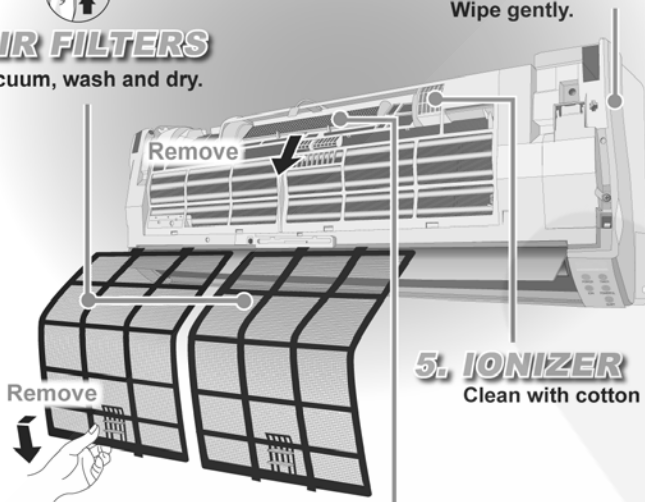

5. IONIZER

Clean with cotton bud.

Remove



6. SUPER ALLERU-BUSTER FILTER

Vacuum the super alleru-buster filter.



■ Cleaning Instructions

- Do not use benzene, thinner or scouring powder.
- Use soaps or neutral household detergent (pH7) only.
- Do not use water with temperature higher than 40°C.

FRONT PANEL & TOP GRILL

- Do not remove the movable panel from front panel.
- Do not dry under direct sunlight.

AIR FILTER

- Purchase the replacement filter if it is damaged.
Part no.: CWD001105

SUPER ALLERU-BUSTER FILTER

- Replace the filter every 3 years or purchase the replacement filter if it is damaged.
Part no.: CZ-SA14P

■ Preparation for extended Non-operation

- Manually activate the odour removal/fungus prevention operation to clean the internal parts.
- Turn off the power supply and unplug.
- Remove the remote control batteries.

■ Pre-season Inspection

- This inspection is recommended before operating the air conditioner at every season.
- Check if the remote control batteries needed to be replaced.
- Ensure there are no obstruction at all air intake and outlet vents.



Hints

- Clean the filter regularly as dirty filters will cause unpurified air, low cooling or heating capacity, unpleasant smells and higher energy consumption.
- The unit will become dirty and the performance of the unit will decrease after used for several seasons. Please consult an authorized dealer to perform seasonal inspections in addition to regular cleaning.
- This air conditioner is equipped with a built-in surge protective device. However, in order to prevent electrical shock and to further protect your air conditioner from being damaged by abnormally strong lightning activity, you may switch off the power supply and do not touch the air conditioner.



Troubleshooting

- Air conditioner does not cool or heat efficiently.
 - Ensure the temperature has been set correctly.
 - Ensure windows and doors have been closed properly.
 - Ensure filters are cleaned or replaced when necessary.
 - Ensure inlet and outlet vents of outdoor unit have not been obstructed.

11 Installation Instructions

Required tools for Installation Works			
1. Philips screw driver	5. Spanner	9. Gas leak detector	13. Multimeter
2. Level gauge	6. Pipe cutter	10. Measuring tape	14. Torque wrench 18 N.m (1.8 kgf.m) 42 N.m (4.2 kgf.m) 55 N.m (5.5 kgf.m)
3. Electric drill, hole core drill (ø70 mm)	7. Reamer	11. Thermometer	15. Vacuum pump
4. Hexagonal wrench (4 mm)	8. Knife	12. Megameter	16. Gauge manifold

11.1. Safety Precautions

- Read the following "SAFETY PRECAUTIONS" carefully before installation.
- Electrical work must be installed by a licensed electrician. Be sure to use the correct rating of the power plug and main circuit for the model to be installed.
- The caution items stated here must be followed because these important contents are related to safety. The meaning of each indication used is as below. Incorrect installation due to ignoring of the instruction will cause harm or damage, and the seriousness is classified by the following indications.





 WARNING	This indication shows the possibility of causing death or serious injury.
--	---

 CAUTION	This indication shows the possibility of causing injury or damage to properties only.
--	---

The items to be followed are classified by the symbols:

	Symbol with background white denotes item that is PROHIBITED from doing.
---	--

- Carry out test running to confirm that no abnormality occurs after the installation. Then, explain to user the operation, care and maintenance as stated in instructions. Please remind the customer to keep the operating instructions for future reference.

 WARNING	
1. Engage dealer or specialist for installation. If installation done by the user is defective, it will cause water leakage, electrical shock or fire.	
2. Install according to this installation instruction strictly. If installation is defective, it will cause water leakage, electrical shock or fire.	
3. Use the attached accessories parts and specified parts for installation. Otherwise, it will cause the set to fall, water leakage, fire or electrical shock.	
4. Install at a strong and firm location which is able to withstand the set's weight. If the strength is not enough or installation is not properly done, the set will drop and cause injury.	
5. For electrical work, follow the local national wiring standard, regulation and this installation instruction. An independent circuit and single outlet must be used. If electrical circuit capacity is not enough or defect found in electrical work, it will cause electrical shock or fire.	
6. Use the specified cable (1.5 mm ²) and connect tightly for indoor/outdoor connection. Connect tightly and clamp the cable so that no external force will be acted on the terminal. If connection or fixing is not perfect, it will cause heat-up or fire at the connection.	
7. Wire routing must be properly arranged so that control board cover is fixed properly. If control board cover is not fixed perfectly, it will cause heat-up at connection point of terminal, fire or electrical shock.	
8. When carrying out piping connection, take care not to let air substances other than the specified refrigerant go into refrigeration cycle. Otherwise, it will cause lower capacity, abnormal high pressure in the refrigeration cycle, explosion and injury.	
9. When connecting the piping, do not allow air or any substances other than the specified refrigerant (R410A) to enter the refrigeration cycle. Otherwise, this may lower the capacity, cause abnormally high pressure in the refrigeration cycle, and possibly result in explosion and injury.	
10. <ul style="list-style-type: none"> • When connecting the piping, do not use any existing (R22) pipes and flare nuts. Using such same may cause abnormally high pressure in the refrigeration cycle (piping), and possible result in explosion and injury. Use only R410A materials. • Thickness of copper pipes used with R410A must be more than 0.8 mm. Never use copper pipes thinner than 0.8mm. • It is desirable that the amount of residual oil is less than 40 mg/10 m. 	
11. Do not modify the length of the power supply cord or use of the extension cord, and do not share the single outlet with other electrical appliances. Otherwise, it will cause fire or electrical shock.	



CAUTION

1. The equipment must be earthed and install with earth breaker. It may cause electrical shock if grounding is not perfect.
2. Do not install the unit at place where leakage of flammable gas may occur.
In case gas leaks and accumulates at surrounding of the unit, it may cause fire. 
3. Carry out drainage piping as mentioned in installation instructions. If drainage is not perfect, water may enter the room and damage the furniture.

ATTENTION

1. Selection of the installation location.
Select an installation location which is rigid and strong enough to support or hold the unit, and select a location for easy maintenance.
2. Power supply connection to the room air conditioner.
Connect the power supply cord of the room air conditioner to the mains using one of the following method.
Power supply point shall be the place where there is ease for access for the power disconnection in case of emergency.
In some countries, permanent connection of this room air conditioner to the power supply is prohibited.
 1. Power supply connection to the receptacle using a power plug.
Use an approved 15A/16A power plug with earth pin for the connection to the socket.
 2. Power supply connection to a circuit breaker for the permanent connection. Use an approved 16A circuit breaker for the permanent connection. It must be a double pole switch with a minimum 3.5 mm contact gap.
3. Do not release refrigerant.
Do not release refrigerant during piping work for installation, reinstallation and during repairing a refrigeration parts.
Take care of the liquid refrigerant, it may cause frostbite.
4. Installation work.
It may need two people to carry out the installation work.
5. Do not install this appliance in a laundry room or other location where water may drip from the ceiling, etc.

Attached accessories

No.	Accessories part	Qty.	No.	Accessories part	Qty.
1	Installation plate	1	7	Super alleru – buster filter	1
2	Installation plate fixing screw	6	8	Pipe hold band	1
3	Remote control	1	9	Oxygen tube joint	1
4	Battery	2	10	Oxygen tube	1
5	Remote control holder	1	11	Drain elbow	1
6	Remote control holder fixing screw	2			

Applicable piping kit
 CZ-3F5, 7BP (HE9DKE)
 CZ-4F5, 7, 10BP (HE12DKE)

SELECT THE BEST LOCATION

INDOOR UNIT

- There should not be any heat source or steam near the unit.
- There should not be any obstacles blocking the air circulation.
- A place where air circulation in the room is good.
- A place where drainage can be easily done.
- A place where noise prevention is taken into consideration.
- Do not install the unit near the door way.
- Ensure the spaces indicated by arrows from the wall, ceiling, fence or other obstacles.
- Recommended installation height for indoor unit shall be at least 2.5 m.

OUTDOOR UNIT

- If an awning is built over the unit to prevent direct sunlight or rain, be careful that heat radiation from the condenser is not obstructed.
- There should not be any animal or plant which could be affected by hot air discharged.
- Keep the spaces indicated by arrows from wall, ceiling, fence or other obstacles.
- Do not place any obstacles which may cause a short circuit of the discharged air.
- If piping length is over the common length, additional refrigerant should be added as shown in the table.

Model	PIPE size		Rated Length (m)	Max Elevation (m)	Max Piping Length (m)	Additional Refrigerant (g/m)
	Gas	Liquid				
HE9DKE	3/8"	1/4"	7.5	12	15	20
HE12DKE	1/2"	1/4"	7.5	12	15	20

Indoor/Outdoor Unit Installation Diagram

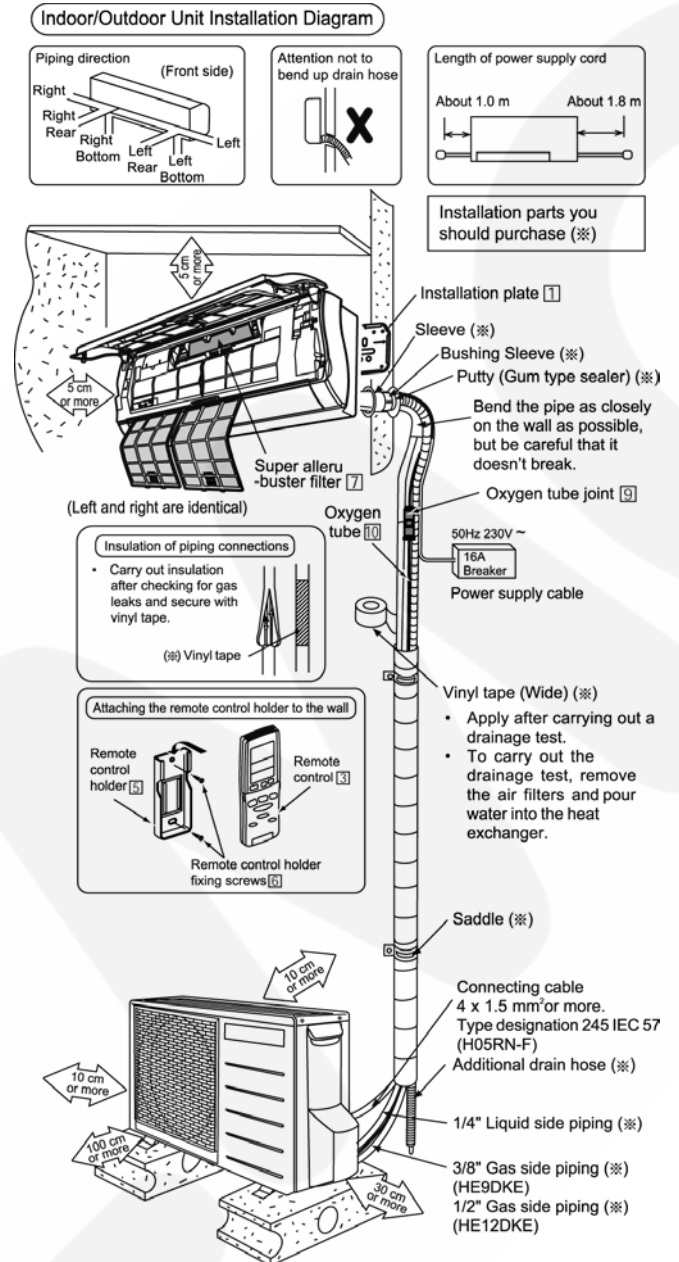

• This illustration is for explanation purposes only. The indoor unit will actually face a different way.

11.2. Indoor Unit

11.2.1. Select The Best Location (Refer to “Select the best location” section)

11.2.2. How To Fix Installation Plate

The mounting wall is strong and solid enough to prevent it from the vibration.

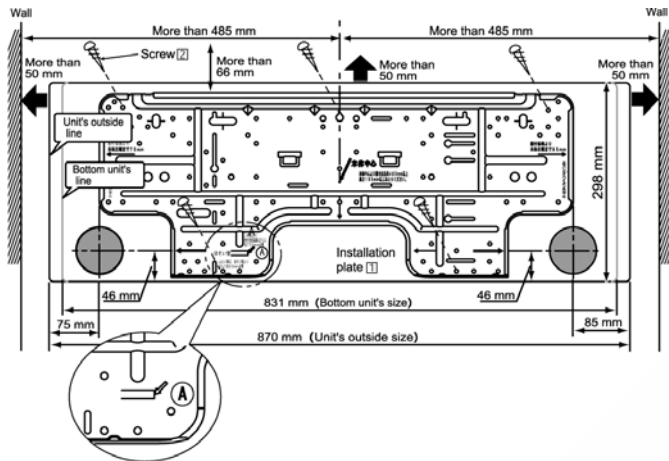

- Ⓐ : For left side piping, piping connection for liquid should be this line.
 : For left side piping, piping connection for gas should be about 60 mm from this line.
 : For left side piping, piping connecting cable should be about 750 mm from this line.

1. Mount the installation plate on the wall with 5 screws or more.

(If mounting the unit on the concrete wall, consider using anchor bolts.)

- Always mount the installation plate horizontally by aligning the marking-off line with the thread and using a level gauge.

2. Drill the piping plate hole with $\varnothing 70$ mm hole-core drill.

- The center of the right piping hole is at the intersection of lines extending vertically from the edge of the installation plate and horizontally from the sideways arrow on the installation plate (see figure above.).
- The center of the left piping hole is at the intersection of lines extending vertically from the downward arrow on the installation plate and horizontally from the sideways arrow on the installation plate (see figure above.).
- Drill the piping hole at either the right or the left and the hole should be slightly slanted to the outdoor side.

11.2.3. To Drill A Hole In The Wall And Install A Sleeve Of Piping

1. Insert the piping sleeve to the hole.
2. Fix the bushing to the sleeve.
3. Cut the sleeve until it extrudes about 15 mm from the wall.

Caution

When the wall is hollow, please be sure to use the sleeve for tube ass'y to prevent dangers caused by mice biting the connecting cable.

4. Finish by sealing the sleeve with putty or caulking compound at the final stage.

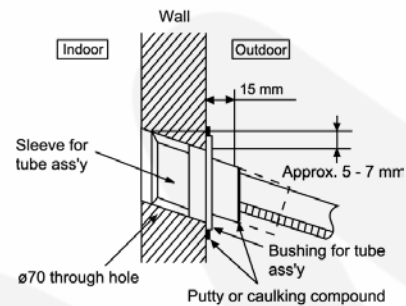

11.2.4. Indoor Unit Installation

1. For the right rear piping

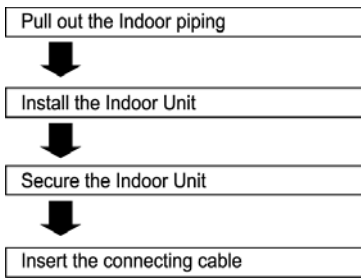

2. For the right and right bottom piping

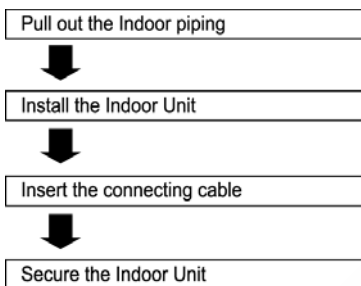

3. For the embedded piping

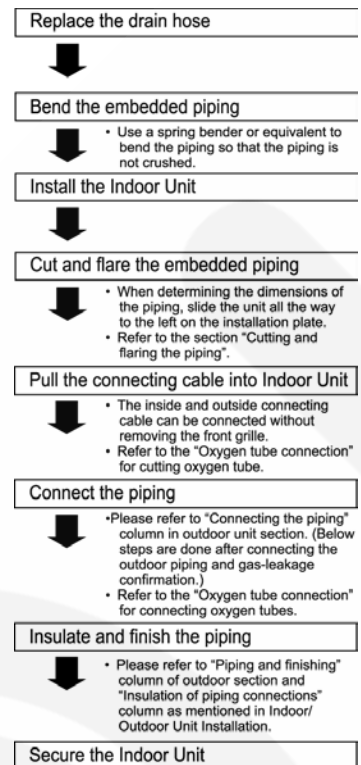

Pull out the piping and drain hose

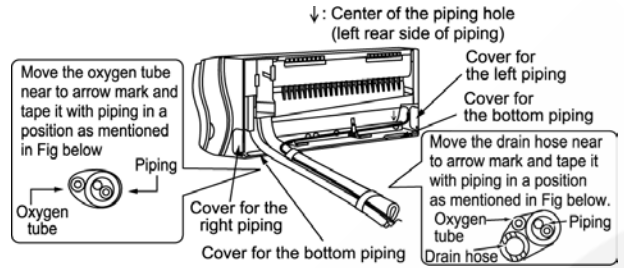

How to keep the cover

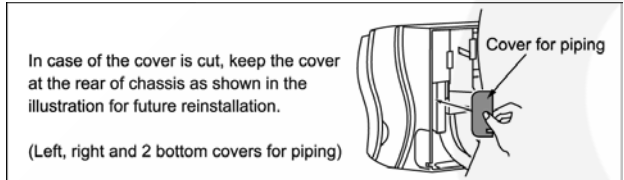

Insert the connecting cable

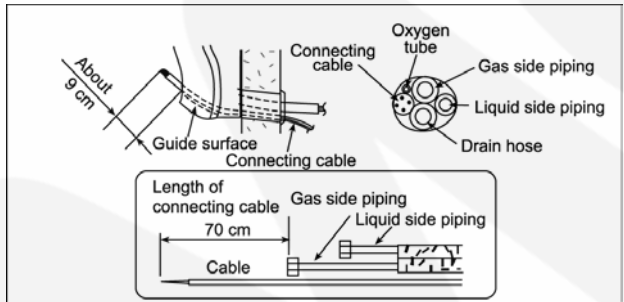

Install the Indoor Unit

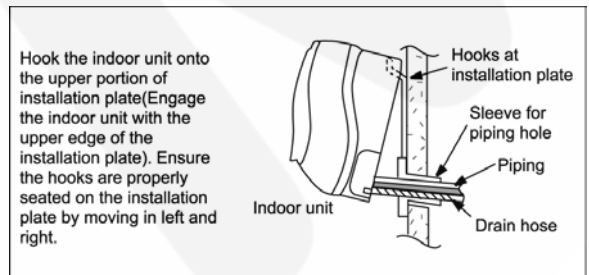

Secure the Indoor Unit

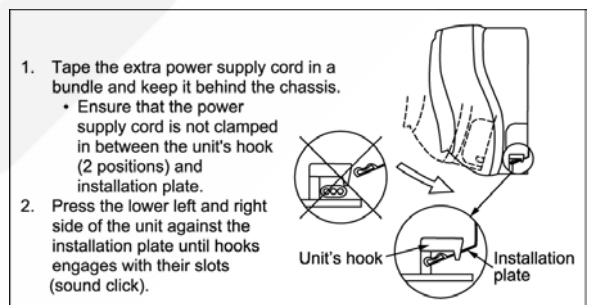

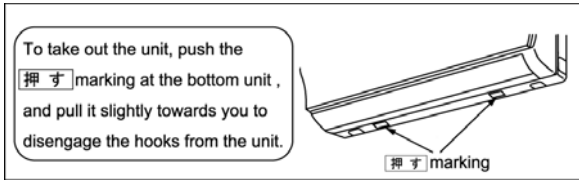

(This can be used for left rear piping & left bottom piping also.)

Exchange the drain hose and the cap.

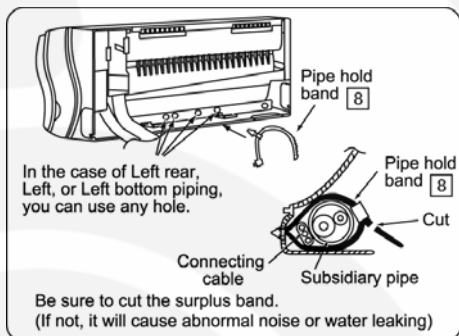
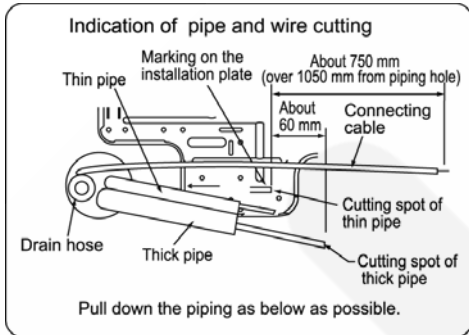
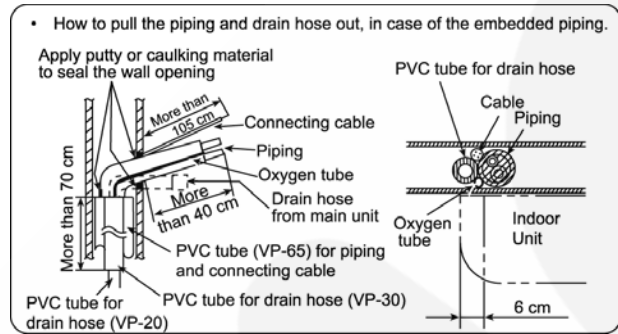
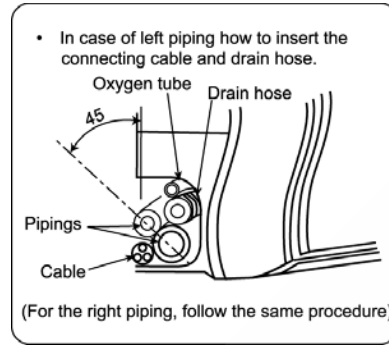
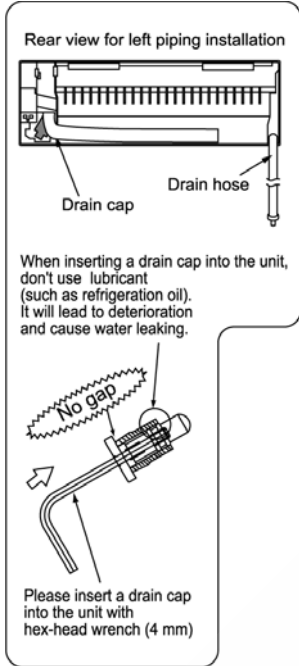

11.2.5. Connect The Cable To The Indoor Unit

1. The inside and outside connecting cable can be connected without removing the front grille.
2. Connecting cable between indoor unit and outdoor unit shall be approved polychloroprene sheathed $4 \times 1.5 \text{ mm}^2$ flexible cord, type designation 245 IEC 57 (H05RN-F) or heavier cord.
 - Ensure the color of wires of outdoor unit and the terminal Nos. are the same to the indoor's respectively.
 - Earth lead wire shall be longer than the other lead wires as shown in the figure for the electrical safety in case of the slipping out of the cord from the anchorage.

Terminals on the indoor unit	1	2	3	
Color of wires				
Terminals on the outdoor unit	1	2	3	

- Secure the cable onto the control board with the holder (clamper).

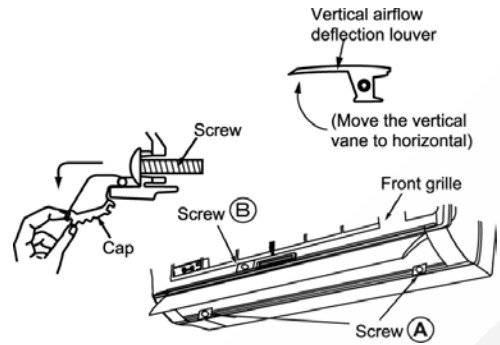
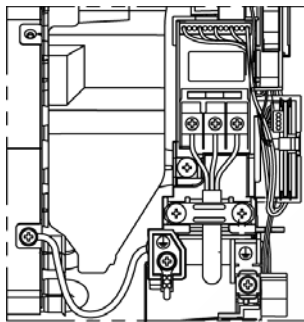

AUTO SWITCH OPERATION

The below operations will be performed by pressing the "AUTO" switch.

- **AUTO OPERATION MODE**

The Auto operation will be activated immediately once the Auto Switch is pressed.

- **TEST RUN OPERATION (for PUMP DOWN/SERVICING PURPOSE)**

The Test Run operation will be activated if the Auto Switch is pressed continuously for more than 5 sec. to below 8 sec. A "pep" sound will occur at the fifth sec., in order to identify the starting of Test Run operation.

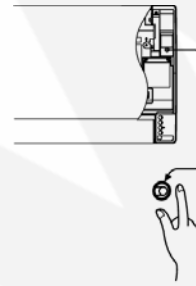

HOW TO TAKE OUT CORNER PIECE (LEFT UNDER)

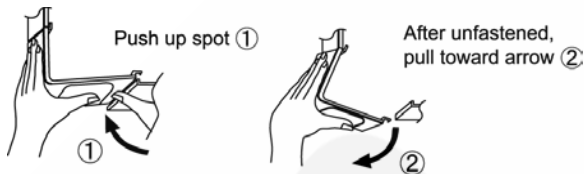

HOW TO TAKE OUT FRONT GRILLE

Please follow the steps below to take out front grille if necessary such as when servicing.

1. Set the vertical airflow direction louver to the horizontal position.
2. Slide down the two caps on the front grille as shown in the illustration at the right, and then remove the three mounting screws.
3. Pull the lower section of the front grille towards you to remove the front grille.

Caution

When reinstalling the front grille, first set the vertical airflow direction louver to the horizontal position and then carry out above steps 2 - 3 in the reverse order. Please check that the top side of front grille certainly caught with fixative rib (4 points) of indoor unit.

11.3. Outdoor Unit

11.3.1. Select The Best Location (Refer to “Select the best location” section)

11.3.2. Install The Outdoor Unit

- After selecting the best location, start installation according to Indoor/Outdoor Unit Installation Diagram.

1. Fix the unit on concrete or rigid frame firmly and horizontally by bolt nut. (ø10 mm).
2. When installing at roof, please consider strong wind and earthquake. Please fasten the installation stand firmly with bolt or nails.

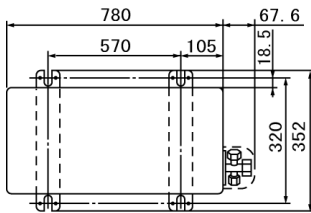

11.3.3. Connecting The Piping

Connecting The Piping To Indoor Unit

Please make flare after inserting flare nut (locate at joint portion of tube assembly) onto the copper pipe. (In case of using long piping)

Connect the piping

- Align the center of piping and sufficiently tighten the flare nut with fingers.
- Further tighten the flare nut with torque wrench in specified torque as stated in the table.

11.3.4. Evacuation Of The Equipment (For Europe & Oceania Destination)

WHEN INSTALLING AN AIR CONDITIONER, BE SURE TO EVACUTE THE AIR INSIDE THE INDOOR UNIT AND PIPES in the following procedure.

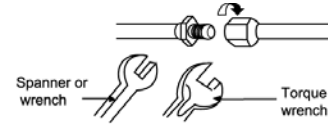
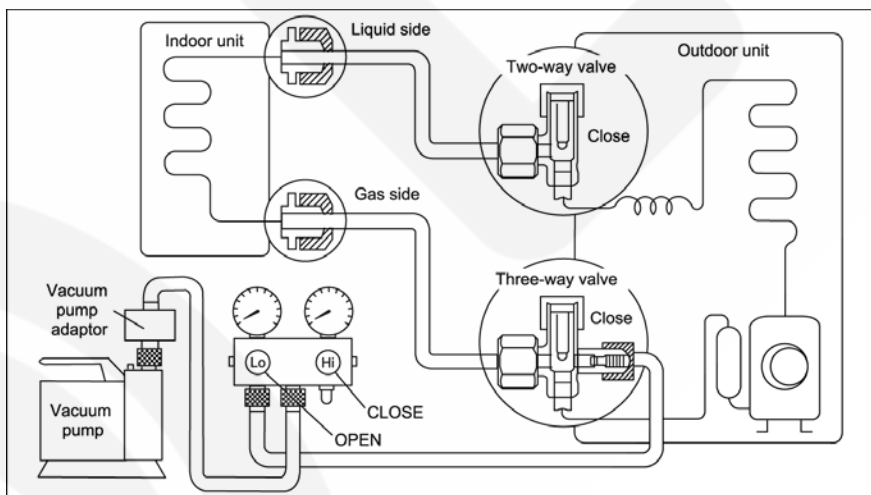

Model	Piping size (Torque)	
	Gas	Liquid
HE9DKE	3/8" [42 N•m]	1/4" [18 N•m]
HE12DKE	1/2" [55 N•m]	1/4" [18 N•m]

Connecting The Piping To Outdoor Unit

Decide piping length and then cut by using pipe cutter. Remove burrs from cut edge. Make flare after inserting the flare nut (located at valve) onto the copper pipe.

Align center of piping to valves and then tighten with torque wrench to the specified torque as stated in the table.

Cutting And Flaring The Piping

1. Please cut using pipe cutter and then remove the burrs.
2. Remove the burrs by using reamer. If burrs is not removed, gas leakage may be caused.
Turn the piping end down to avoid the metal powder entering the pipe.
3. Please make flare after inserting the flare nut onto the copper pipes.

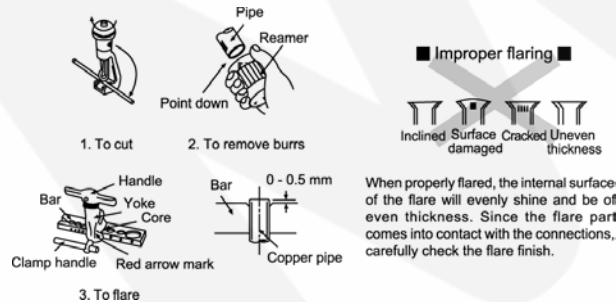

1. Connect a charging hose with a push pin to the Low and High side of a charging set and the service port of the 3-way valve.
 - Be sure to connect the end of the charging hose with the push pin to the service port.
2. Connect the center hose of the charging set to a vacuum pump with check valve, or vacuum pump and vacuum pump adaptor.
3. Turn on the power switch of the vacuum pump and make sure that the needle in the gauge moves from 0 cmHg (0 MPa) to -76cm Hg (-0.1 MPa). Then evacuate the air approximately 15 minutes.
4. Close the Low side valve of the charging set the turn off the vacuum pump. Make sure that the needle in the gauge does not move after approximately 5 minutes.

Note: BE SURE TO FOLLOW THIS PROCEDURE INORDER TO AVOID REFRIGERANT GAS LEAKAGE.







5. Disconnect the charging hose from vacuum pump and from the service port of the 3-way valve.
6. Tighten the service port caps of the 3-way valve at a torque of 18 N.m with a torque wrench.
7. Remove the valve caps of both of the 3-way valve. Position both of the valves to "OPEN" using a hexagonal wrench (4 mm).
8. Mount valve caps onto the 2-way valve and the 3-way valve.
 - Be sure to check for gas leakage.

Caution

- If gauge needle does not move from 0 cmHg (0 MPa) to -76 cmHg (-0.1 MPa), in step 3 above take the following measure:
- If the leak stops when the piping connections are tightened further, continue working from step 3.
- If the leak does not stop when the connections are retightened, repair the location of leak.
- Do not release refrigerant during piping work for installation and reinstallation. Take care of the liquid refrigerant, it may cause frostbite.

11.3.5. Connect The Cable To The Outdoor Unit

1. Remove the control board cover from the unit by loosening the screw.
2. Connecting cable between indoor unit and outdoor unit shall be approved polychloroprene sheathed $4 \times 1.5 \text{ mm}^2$ flexible cord, type designation 245 IEC 57 (H05RN-F) or heavier cord.

Terminals on the indoor unit	1	2	3	
Color of wires				
Terminals on the outdoor unit	1	2	3	

3. Secure the cable onto the control board with the holder (clammer).
4. Attach the control board cover back to the original position with the screw.

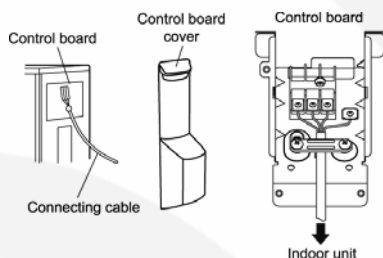

11.3.6. Pipe Insulation

1. Please carry out insulation at pipe connection portion as mentioned in Indoor/Outdoor Unit Installation Diagram. Please wrap the insulated piping end to prevent water from going inside the piping.
2. If drain hose or connecting piping is in the room (where dew may form), please increase the insulation by using POLY-E FOAM with thickness 6 mm or above.

FOR 2 SETS IN ONE ROOM

A switching mechanism to prevent errors occurring in the operation of one of the air conditioners caused by operating the buttons on the remote controller for the other air conditioner is provided. This mechanism was set to "A" at the factory.

Set the other air conditioner and its remote controller to "B".

- Set the remote controller to "B".

Open the remote controller's battery cover, and cut the jumper using a pair of pliers.

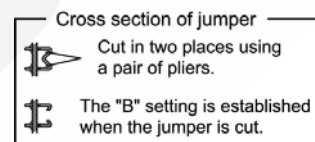

- Set the air conditioner to "B".

1. Hold down the air conditioner's emergency operation button for at least 11 seconds, and release it after three beeps are heard.

(Note: One beep is heard after the button has been held down for 5 seconds, and two beeps are heard after 8 seconds.)

2. Within the next 5 minutes, point the remote controller at the air conditioner, and press the ERROR RESET button on the remote controller. (A beep is heard, indicating that this signal was received.)
3. When any button on the remote controller which has been set to "B" is pressed within the next 5 minutes, the air conditioner will also be set to "B". (Another beep is heard, indicating that this signal was received.)
4. Check that the air conditioner which has been set to "B" can be operated by the remote controller which has been set to "B".

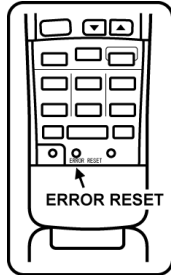

DISPOSAL OF OUTDOOR UNIT DRAIN WATER

- If a drain elbow is used, the unit should be placed on a stand which is taller than 3 cm.
- If the unit is used in an area where temperature falls below 0°C for 2 or 3 days in succession, it is recommended not to use a drain elbow, for the drain water freezes and the fan will not rotate.

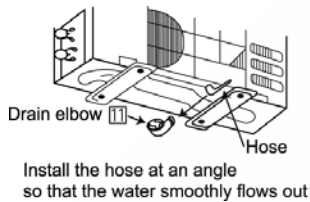

CHECK THE DRAINAGE

- Open front panel and remove air filters. (Drainage checking can be carried out without removing the front grille.)
- Pour a glass of water into the drain tray-styrofoam.
- Ensure that water flows out from drain hose of the indoor unit.

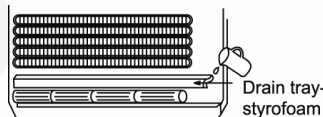

EVALUATION OF THE PERFORMANCE

- Operate the unit at cooling operation mode for 15 minutes or more.
- Measure the temperature of the intake and discharge air.
- Ensure the difference between the intake temperature and the discharge is more than 8°C.

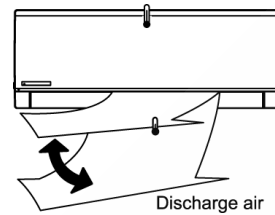

CHECK ITEMS

- Is there any gas leakage at flare nut connection?
- Has the heat insulation been carried out at flare nut connection?
- Is the connecting cable being fixed to terminal board firmly?
- Is the connecting cable being clamped firmly?
- Is the drainage OK? (Refer to "Check the drainage" section)
- Is the earth wire connection properly done?
- Is the indoor unit properly hooked to the installation plate?
- Is the power supply voltage complied with rated value?
- Is there any abnormal sound?
- Is the cooling operation normal?
- Is the thermostat operation normal?
- Is the remote control's LCD operation normal?
- Is the air purifying filter installed?

12 Installation and Servicing Air Conditioner Using R410A

12.1. Outline

12.1.1. About R410A Refrigerant

1. Converting air conditioners to R410A

Since it was declared in 1974 that chlorofluorocarbons (CFC), hydro chlorofluorocarbons (HCFC) and other substances pose a destructive danger to the ozone layer in the earth's upper stratosphere (20 to 40 km above the earth), measures have been taken around the world to prevent this destruction.

The R22 refrigerant which has conventionally been used in ACs is an HCFC refrigerant and, therefore, possesses this ozone-destroying potential. International regulations (the Montreal Protocol on Ozone-Damaging Substances) and the domestic laws of various countries call for the early substitution of R22 by a refrigerant which will not harm the ozone layer.

- In ACs, the HFC refrigerant which has become the mainstream alternative is called R410A. Compared with R22, the pressure of R410A is approximately 1.6 times as high at the same refrigerant temperature, but the energy efficiency is about the same. Consisting of hydrogen (H), fluorine (F) and carbon (C), R410A is an HFC refrigerant. Another typical HFC refrigerant is R407C. While the energy efficiency of R407C is somewhat inferior to that of R410A, it offers the advantage of having pressure characteristics which are about the same as those of R22, and is used mainly in packaged ACs.

2. The characteristics of HFC (R410A) refrigerants

a. Chemical characteristics

The chemical characteristics of R410A are similar to those of R22 in that both are chemically stable, non-flammable refrigerants with low toxicity.

However, just like R22, the specific gravity of R410A gas is heavier than that of air. Because of this, it can cause an oxygen deficiency if it leaks into a closed room since it collects in the lower area of the room. It also generates toxic gas when it is directly exposed to a flame, so it must be used in a well ventilated environment where it will not collect.

Table 1 Physical comparison of R410A and R22

	R410A	R22
Composition (wt%)	R32/R125 (50/50)	R22 (100)
Boiling point (°C)	-51.4	-40.8
Vaporizing pressure (25°C)	1.56 Mpa (15.9 kgf/cm ²)	0.94 Mpa (9.6 kgf/cm ²)
Saturated vapor density	64.0 kg/m ³	44.4 kg/m ³
Flammability	Non-flammable	Non-flammable
Ozone-destroying point (ODP)	0	0.055
Global-warming point (GWP)	1730	1700

b. Compositional change (pseudo-azeotropic characteristics)

R410A is a pseudo-azeotropic mixture comprising the two components R32 and R125. Multi-component refrigerants with these chemical characteristics exhibit little compositional change even from phase changes due to vaporization (or condensation), which means that there is little change in the circulating refrigerant composition even when the refrigerant leaks from the gaseous section of the piping.

Accordingly, R410A can be handled in almost the same manner as the single-component refrigerant R22. However, when charging, because there is a slight change in composition between the gas phase and the liquid phase inside a cylinder or other container, charging should basically begin with the liquid side.

c. Pressure characteristics

As seen in Table 2, the gas pressure of R410A is approximately 1.6 times as high as that of R22 at the same refrigerant temperature, which means that special R410A tools and materials with high-pressure specifications must be used for all refrigerant piping work and servicing.

Table 2 Comparison of R410A and R22 saturated vapor density

Refrigerant Temperature (°C)	Unit: MPa	
	R410A	R22
-20	0.30	0.14
0	0.70	0.40
20	1.35	0.81
40	2.32	1.43
60	3.73	2.33
65	4.15	2.60

d. R410A refrigerating machine oil

Conventionally, mineral oil or a synthetic oil such as alkylbenzene has been used for R22 refrigerating machine oil. Because of the poor compatibility between R410A and conventional oils like mineral oil, however, there is a tendency for the refrigerating machine oil to collect in the refrigerating cycle. For this reason, polyester and other synthetic oils which have a high compatibility with R410A are used as refrigerating machine oil.

Because of the high hygroscopic property of synthetic oil, more care must be taken in its handling than was necessary with conventional refrigerating machine oils. Also, these synthetic oils will degrade if mixed with mineral oil or alkylbenzene, causing clogging in capillary tubes or compressor malfunction. Do not mix them under any circumstances.

12.1.2. Safety Measures When Installing/Serviceing Refrigerant Piping

Cause the gas pressure of R410A is approximately 1.6 times as high as that of R22, a mistake in installation or servicing could result in a major accident. It is essential that you use R410A tools and materials, and that you observe the following precautions to ensure safety.

1. Do not use any refrigerant other than R410A in ACs that have been used with R410A.
2. If any refrigerant gas leaks while you are working, ventilate the room. Toxic gas may be generated if refrigerant gas is exposed to a direct flame.
3. When installing or transferring an AC, do not allow any air or substance other than R410A to mix into the refrigeration cycle. If it does, the pressure in the refrigeration cycle can become abnormally high, possibly causing an explosion and/or injury.
4. After finishing the installation, check to make sure there is no refrigerant gas leaking.
5. When installing or transferring an AC, follow the instructions in the installation instructions carefully. Incorrect installation can result in an abnormal refrigeration cycle or water leakage, electric shock, fire, etc.
6. Do not perform any alterations on the AC unit under any circumstances. Have all repair work done by a specialist. Incorrect repairs can result in a water leakage, electric shock, fire, etc.

12.2. Tools For Installing/Serviceing Refrigerant Piping

12.2.1. Necessary Tools

In order to prevent an R410A AC from mistakenly being charged with any other refrigerant, the diameter of the 3-way valve service port on the outdoor unit has been changed. Also, to increase its ability to withstand pressure, the opposing dimensions have been changed for the refrigerant pipe flaring size and flare nut. Accordingly, when installing or servicing refrigerant piping, you must have both the R410A and ordinary tools listed below.

Table 3 Tools for installation, transferring or replacement

Type of work	Ordinary tools	R410A tools
Flaring	Flaring tool (clutch type), pipe cutter, reamer	Copper pipe gauge for clearance Adjustment, flaring tool (clutch type)*1)
Bending, connecting pipes	Torque wrench (nominal diameter 1/4, 3/8, 1/2). Fixed spanner (opposing sides 12 mm, 17 mm, 19 mm). Adjustable wrench, Spring bender	
Air purging	Vacuum pump. Hexagonal wrench (opposing sides 4 mm)	Manifold gauge, charging hose, vacuum pump adaptor
Gas leak inspection	Gas leak inspection fluid or soapy water	Electric gas leak detector for HFC refrigerant*2)

*1) You can use the conventional (R22) flaring tool. If you need to buy a new tool, buy the R410A type.

*2) Use when it is necessary to detect small gas leaks.

For other installation work, you should have the usual tools, such as screwdrivers (+,-), a metal-cutting saw, an electrical drill, a hole core drill (65 or 70 dia.), a tape measure, a level, a thermometer, a clamp meter, an insulation tester, a voltmeter, etc.

Table 4 Tools for serving

Type of work	Ordinary tools	R410A tools
Refrigerant charging		Electronic scale for refrigerant charging. Refrigerant cylinder. Charging orifice and packing for refrigerant cylinder
Brazing (Replacing refrigerating cycle part*1)	Nitrogen blow set (be sure to use nitrogen blowing for all brazing), and brazing machine	

*1) Always replace the dryer of the outdoor unit at the same time. The replacement dryer is wrapped in a vacuum pack. Replace it last among the refrigerating cycle parts. Start brazing as soon as you have opened the vacuum pack, and begin the vacuuming operation within 2 hours.

12.2.2. R410A Tools

1. Copper tube gauge for clearance adjustment
(used when flaring with the conventional flaring tool (clutch type))

- This gauge makes it easy to set the clearance for the copper tube to 1.0-1.5 mm from the clamp bar of the flaring tool.

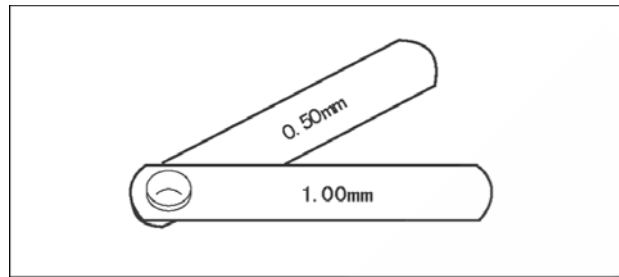

Fig. 1 Copper tube gauge for clearance adjustment

2. Flaring tool (clutch type)

- In the R410A flaring tool, the receiving hole for the clamp bar is enlarged so the clearance from the clamp bar can be set to 0-0.5 mm, and the spring inside the tool is strengthened to increase the strength of the pipe-expanding torque. This flaring tools can also be used with R22 piping, so we recommend that you select it if you are buying a new flaring tool.

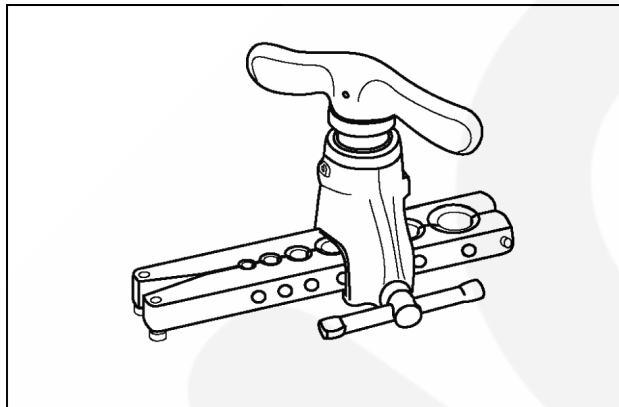

Fig. 2 Flaring tool (clutch type)

3. Torque wrenches

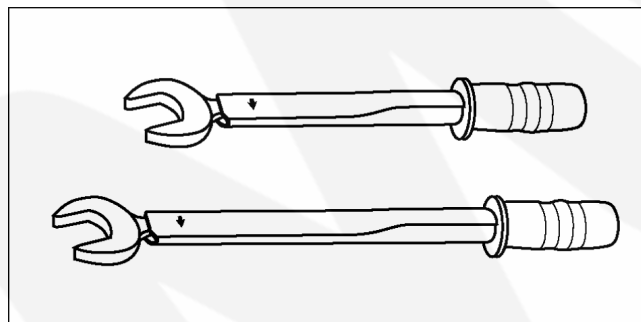

Fig. 3 Torque wrenches

Table 5

	Conventional wrenches	R410A wrenches
For 1/4 (opposite side x torque)	17 mm x 18 N.m (180 kgf.cm)	17 mm x 18 N.m (180 kgf.cm)
For 3/8 (opposite side x torque)	22 mm x 42 N.m (420 kgf.cm)	22 mm x 42 N.m (420 kgf.cm)
For 1/2 (opposite side x torque)	24 mm x 55 N.m (550 kgf.cm)	26 mm x 55 N.m (550 kgf.cm)

4. Manifold gauge

- Because the pressure is higher for the R410A type, the conventional type cannot be used.

Table 6 Difference between R410A and conventional high/low-pressure gauges

	Conventional gauges	R410A gauges
High-pressure gauge (red)	-76 cmHg - 35 kgf/cm ³	-0.1 - 5.3 Mpa -76 cmHg - 53 kgf/cm ³
Low-pressure gauge (blue)	-76 cmHg - 17 kgf/cm ³	-0.1 - 3.8 Mpa -76 cmHg - 38 kgf/cm ³

- The shape of the manifold ports has been changed to prevent the possibility of mistakenly charging with another type of refrigerant.

Table 7 Difference between R410A and conventional manifold port size

	Conventional gauges	R410A gauges
Port size	7/16 UNF 20 threads	1/2 UNF 20 threads

5. Charging hose

- The pressure resistance of the charging hose has been raised to match the higher pressure of R410A. The hose material has also been changed to suit HFC use, and the size of the fitting has been changed to match the manifold ports.

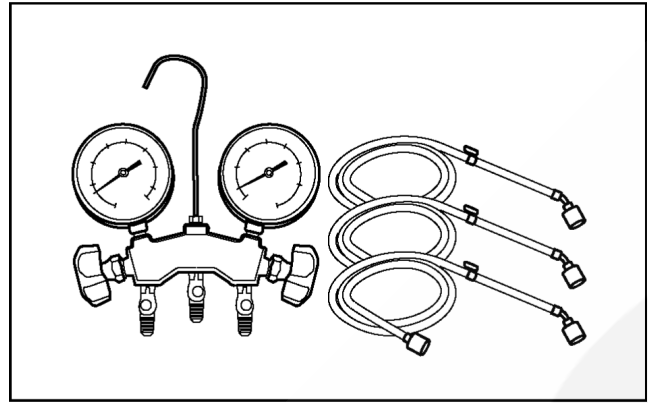

Fig. 4 Manifold gauge charging hose

Table 8 Difference between R410A and conventional charging hoses

		Conventional hoses	R410A hoses
Pressure resistance	Working pressure	3.4 MPa (35 kgf/cm ³)	5.1 MPa (52 kgf/cm ³)
	Bursting pressure	17.2 MPa (175 kgf/cm ³)	27.4 MPa (280 kgf/cm ³)
Material		NBR rubber	HNBR rubber Nylon coating inside

6. Vacuum pump adaptor

- When using a vacuum pump for R410A, it is necessary to install an electromagnetic valve to prevent the vacuum pump oil from flowing back into the charging hose. The vacuum pump adaptor is installed for that purpose. If the vacuum pump oil (mineral oil) becomes mixed with R410A, it will damage the unit.

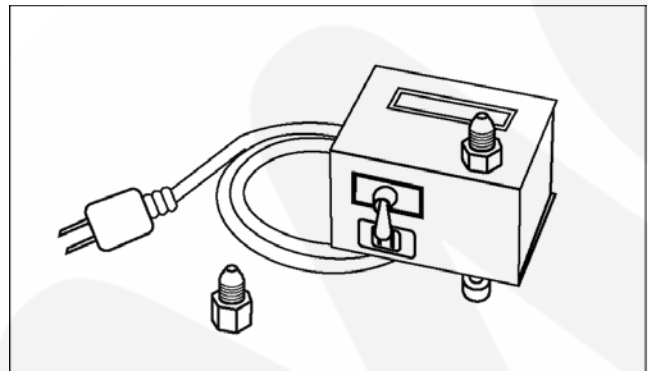

Fig. 5 Vacuum pump adaptor

7. Electric gas leak detector for HFC refrigerant

- The leak detector and halide torch that were used with CFC and HCFC cannot be used with R410A (because there is no chlorine in the refrigerant).
- The present R134a leak detector can be used, but the detection sensitivity will be lower (setting the sensitivity for R134a at 1, the level for R410A will drop to 0.6).
- For detecting small amounts of gas leakage, use the electric gas leak detector for HFC refrigerant. (Detection sensitivity with R410A is about 23 g/year).

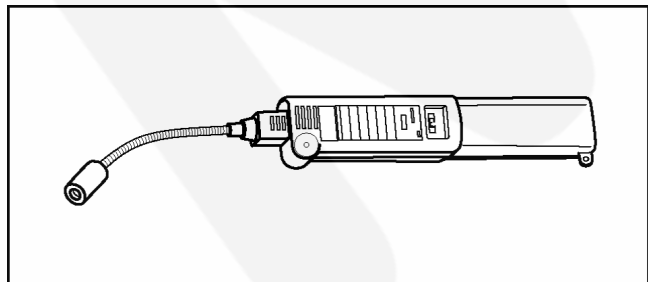

Fig. 6 Electric gas leak detector for HFC refrigerant

8. Electronic scale for refrigerant charging

- Because of the high pressure and fast vaporizing speed of R410A, the refrigerant cannot be held in a liquid phase inside the charging cylinder when charging is done using the charging cylinder method, causing bubbles to form in the measurement scale glass and making it difficult to see the reading. (Naturally, the conventional R22 charging cylinder cannot be used because of the differences in the pressure resistance, scale gradation, connecting port size, etc.)
- The electronic scale has been strengthened by using a structure in which the weight detector for the refrigerant cylinder is held by four supports. It is also equipped with two connection ports, one for R22 (7/16 UNF, 20 threads) and one for R410A (1/2 UNF, 20 threads), so it can also be used for conventional refrigerant charging.
- There are two types of electronic scales, one for 10-kg cylinders and one for 20-kg cylinders. (The 10-kg cylinder is recommended.)

Refrigerant charging is done manually by opening and closing the valve.

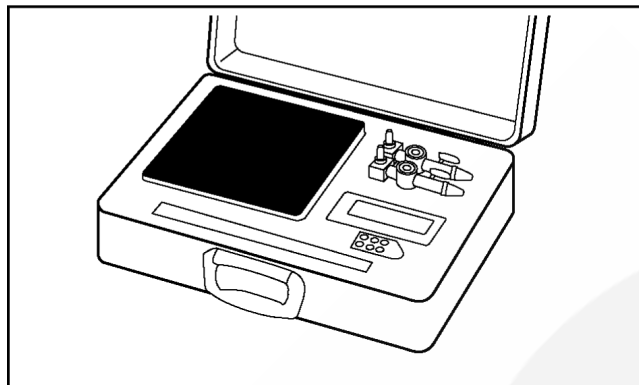

Fig. 7 Electronic scale for refrigerant charging

9. Refrigerant cylinders

- The R410A cylinders are labeled with the refrigerant name, and the coating color of the cylinder protector is pink, which is the color stipulated by ARI of the U.S.
- Cylinders equipped with a siphon tube are available to allow the cylinder to stand upright for liquid refrigerant charging.



Fig. 8 Refrigerant cylinders

10. Charging orifice and packing for refrigerant cylinders

- The charging orifice must match the size of the charging hose fitting (1/2 UNF, 20 threads).
- The packing must also be made of an HFC-resistant material.

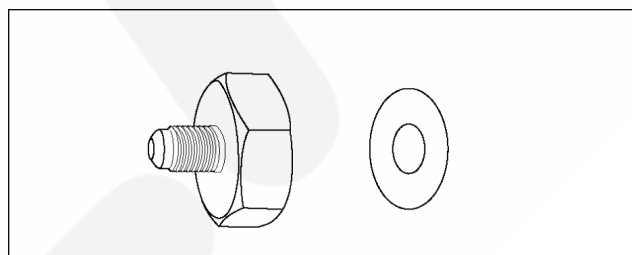

Fig. 9 Charging orifice and packing

12.2.3. R410A Tools Which Are Usable for R22 Models

Table 9 R410A tools which are usable for R22 models

	R410A tools	Usable for R22 models
(1)	Copper tube gauge for clearance adjustment	OK
(2)	Flaring tool (clutch type)	OK
(3)	Manifold gauge	NG
(4)	Charging hose	NG
(5)	Vacuum pump adaptor	OK
(6)	Electric gas leak detector for HFC refrigerant	NG
(7)	Electronic scale for refrigerant charging	OK
(8)	Refrigerant cylinder	NG
(9)	Charging orifice and packing for refrigerant cylinder	NG

12.3. Refrigerant Piping Work

12.3.1. Piping Materials

It is recommended that you use copper and copper alloy jointless pipes with a maximum oil adherence of 40 mg/10m. Do not use pipes that are crushed, deformed, or discolored (especially the inside surface). If these inferior pipes are used, impurities may clog the expansion valves or capillaries.

Because the pressure of ACs using R410A is higher than those using R22, it is essential that you select materials that are appropriate for these standards.

The thickness of the copper tubing used for R410A is shown in Table 10. Please be aware that tubing with a thickness of only 0.7 mm is also available on the market, but this should never be used.

Table 10 Copper tube thickness (mm)

Soft pipe		Thickness (mm)	
Nominal diameter	Outside diameter (mm)	R410A	(Reference) R22
1/4	6.35	0.80	0.80
3/8	9.52	0.80	0.80
1/2	12.7	0.80	0.80

12.3.2. Processing and Connecting Piping Materials

When working with refrigerant piping, the following points must be carefully observed: no moisture or dust must be allowed to enter the piping, and there must be no refrigerant leaks.

1. Procedure and precautions for flaring work

a. Cut the pipe

Use a pipe cutter, and cut slowly so the pipe will not be deformed.

b. Remove burrs and clean shavings from the cut surface

If the shape of the pipe end is poor after removing burrs, or if shavings adhere to the flared area, it may lead to refrigerant leaks.

To prevent this, turn the cut surface downward and remove burrs, then clean the surface, carefully.

c. Insert the flare nut (be sure to use the same nut that is used on the AC unit)

d. Flaring

Check the clamp bar and the cleanliness of the copper pipe.

Be sure to use the clamp bar to do the flaring with accuracy. Use either an R410A flaring tool, or a conventional flaring tool. Flaring tools come in different sizes, so be sure to check the size before using. When using a conventional flaring tool, use the copper pipe gauge for clearance adjustment, etc., to ensure the correct A dimension (see Fig. 10)

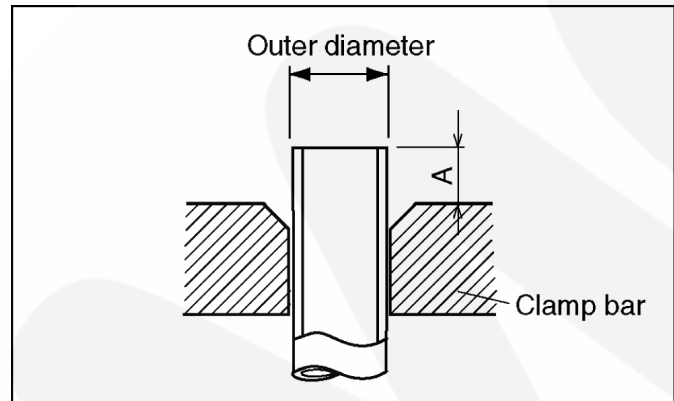

Fig. 10 Flaring dimensions

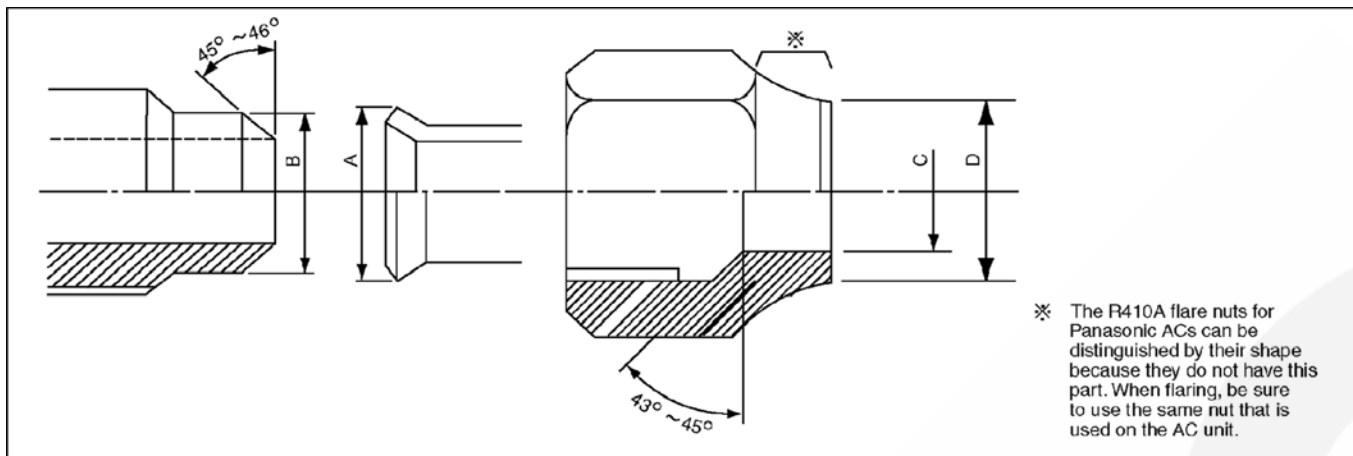

Fig. 11 Relation between the flare nut structure and flaring tool end

Table 11 R410A flaring dimensions

Nominal diameter	Outside diameter (mm)	Wall thickness (mm)	A (mm)		
			R410A flaring tool, clutch type	Conventional flaring tool	
				Clutch type	Wing-nut type
1/4	6.35	0.8	0 - 0.5	1.0 - 1.5	1.5 - 2.0
3/8	9.52	0.8	0 - 0.5	1.0 - 1.5	1.5 - 2.0
1/2	12.70	0.8	0 - 0.5	1.0 - 1.5	2.0 - 2.5

Table 12 R22 flaring dimensions

Nominal diameter	Outside diameter (mm)	Wall thickness (mm)	A (mm)		
			R410A flaring tool, clutch type	Conventional flaring tool	
				Clutch type	Wing-nut type
1/4	6.35	0.8	0 - 0.5	0.5 - 1.0	1.0 - 1.5
3/8	9.52	0.8	0 - 0.5	0.5 - 1.0	1.0 - 1.5
1/2	12.70	0.8	0 - 0.5	0.5 - 1.0	1.5 - 2.0

Table 13 R410A flare and flare nut dimensions Unit: mm

Nominal diameter	Outside diameter (mm)	Wall thickness (mm)	A +0, -0.4	B dimension	C dimension	D dimension	Flare nut width
1/4	6.35	0.8	9.1	9.2	6.5	13	17
3/8	9.52	0.8	13.2	13.5	9.7	20	22
1/2	12.70	0.8	16.6	16.0	12.9	23	26

Table 14 R22 flare and flare nut dimensions Unit: mm

Nominal diameter	Outside diameter (mm)	Wall thickness (mm)	A +0, -0.4	B dimension	C dimension	D dimension	Flare nut width
1/4	6.35	0.8	9.0	9.2	6.5	13	17
3/8	9.52	0.8	13.0	13.5	9.7	20	22
1/2	12.70	0.8	16.2	16.0	12.9	20	24

2. Procedure and precautions for flare connection

- a. Check to make sure there is no scratches, dust, etc., on the flare and union.
- b. Align the flared surface with the axial center of the union.
- c. Use a torque wrench, and tighten to the specified torque. The tightening torque for R410A is the same as the conventional torque value for R22. Be careful, because if the torque is too weak, it may lead to a gas leak. If it is too strong, it may split the flare nut or make it impossible to remove the flare nut.

Table 15 R410A tightening torque

Nominal diameter	Outside diameter (mm)	Tightening torque N.m (kgf.cm)	Torque wrench tightening torque N.m (kgf.cm)
1/4	6.35	14 - 18 (140 - 180)	18 (180)
3/8	9.52	33 - 42 (330 - 420)	42 (420)
1/2	12.70	55 (550)	55 (550)

12.3.3. Storing and Managing Piping Materials

1. Types of piping and their storage

The following is a general classification of the refrigerant pipe materials used for ACs.

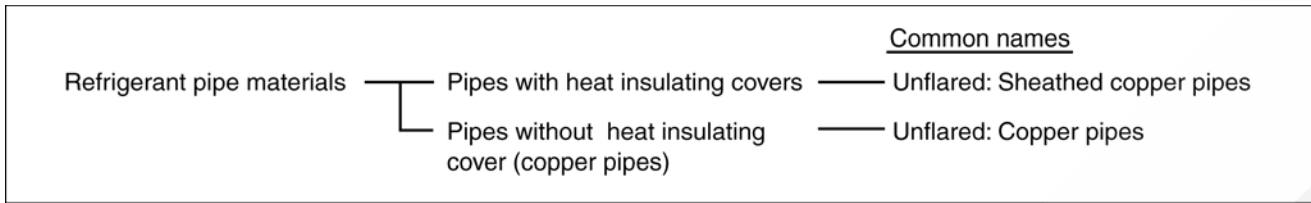

Because the gas pressure of R410A is approximately 1.6 times as high as that of R22, copper pipes with the thickness shown in Table 10, and with minimal impurities must be used. Care must also be taken during storage to ensure that pipes are not crushed, deformed, or scratched, and that no dust, moisture or other substance enters the pipe interior. When storing sheathed copper pipes or plain copper pipes, seal the openings by pinching or taping them securely.

2. Makings and management

a. Sheathed copper pipes and copper-element pipes

When using these pipes, check to make sure that they are the stipulated thickness. For flare nuts, be sure to use the same nut that is used on the AC unit.

b. Copper pipes

Use only copper pipes with the thickness given in table 10, and with minimal impurities. Because the surface of the pipe is exposed, you should take special care, and also take measures such as marking the pipes to make sure they are easily distinguished from other piping materials, to prevent mistaken use.

3. Precautions during refrigerant piping work

Take the following precautions on-site when connecting pipes. (Keep in mind that the need to control the entry of moisture and dust is even more important than in conventional piping).

- a. Keep the open ends of all pipes sealed until connection with AC equipment is complete.
- b. Take special care when doing piping work on rainy days. The entering of moisture will degrade the refrigerating machine oil, and lead to malfunctions in the equipment.
- c. Complete all pipe connections in as short a time as possible. If the pipe must be left standing for a long time after removing the seal, it must be thoroughly purged with nitrogen, or dried with a vacuum pump.

12.4. Installation, Transferring, Servicing

12.4.1. Inspecting Gas Leaks with a Vacuum Pump for New Installations (Using New Refrigerant Piping)

1. From the viewpoint of protecting the global environment, please do not release refrigerant into the atmosphere.
 - a. Connect the projecting side (pin-pushing side) of the charging hose for the manifold gauge to the service port of the 3-way valve. (1)
 - b. Fully open the handle Lo of the manifold gauge and run the vacuum pump. (2) (If the needle of the low-pressure gauge instantly reaches vacuum, re-check step a.)
 - c. Continue the vacuum process for at least 15 minutes, then check to make sure the low-pressure gauge has reached -0.1 MPa (-76 cmHg). Once the vacuum process has finished, fully close the handle Lo of the manifold gauge and stop the vacuum pump operation, then remove the charging hose that is connected to the vacuum pump adaptor. (Leave the unit in that condition for 1-2 minutes, and make sure that the needle of the manifold gauge does not return.) (2) and (3)
 - d. Turn the valve stem of the 2-way valve 90° counter-clockwise to open it, then, after 10 seconds, close it and inspect for a gas leak (4)
 - e. Remove the charging hose from the 3-way valve service port, then open both the 2-way valve and 3-way valve. (1) (4) (Turn the valve stem in the counter-clockwise direction until it gently makes contact. Do not turn it forcefully).
 - f. Tighten the service port cap with a torque wrench (18 N.m (1.8 kgf.m)). (5) Then tighten the 2-way valve and 3-way valve caps with a torque wrench (42 N.m (4.2 kgf.m)) or (55 N.m (5.5 kgf.m)). (6)
 - g. After attaching each of the caps, inspect for a gas leak around the cap area. (5) (6)

Precautions

- Be sure to read the instructions for the vacuum pump, vacuum pump adaptor and manifold gauge prior to use, and follow the instructions carefully.
- Make sure that the vacuum pump is filled with oil up to the designated line on the oil gauge.
- The gas pressure back flow prevention valve on the charging hose is generally open during use. When you are removing the charging hose from the service port, it will come off more easily if you close this valve.

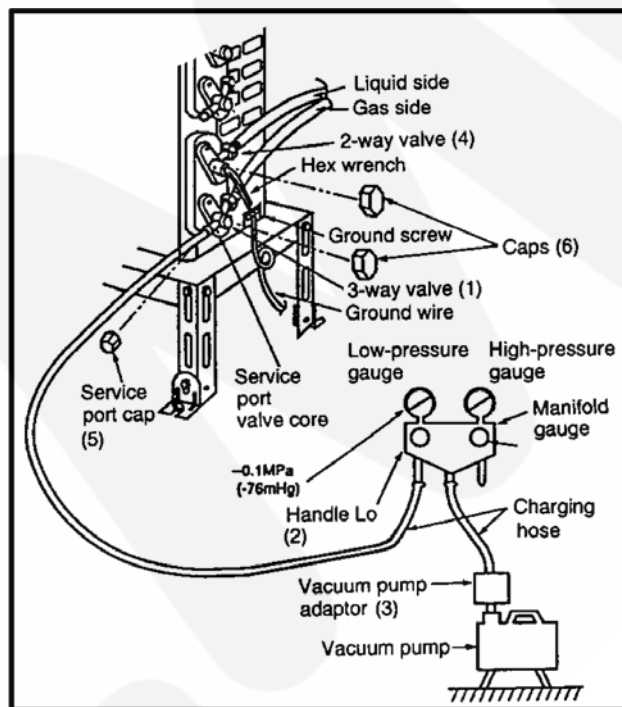

Fig. 12 Vacuum pump air purging configuration

12.4.2. Transferring (Using New Refrigerant Piping)

1. Removing the unit

a. Collecting the refrigerant into the outdoor unit by pumping down

The refrigerant can be collected into the outdoor unit (pumping down) by pressing the TEST RUN button, even when the temperature of the room is low.

- Check to make sure that the valve stems of the 2-way valve and 3-way valve have been opened by turning them counter-clockwise. (Remove the valve stem caps and check to see that the valve stems are fully opened position. Always use a hex wrench (with 4-mm opposing sides) to operate the valve stems.)
- Press the TEST RUN button on the indoor unit, and allow preliminary operation for 5-6 minutes. (TEST RUN mode)
- After stopping the operation, let the unit sit for about 3 minutes, then close the 2-way valve by turning the valve stem in the clockwise direction.
- Press the TEST RUN button on the indoor unit again, and after 2-3 minutes of operation, turn the valve stem of the 3-way valve quickly in the clockwise direction to close it, then stop the operation.
- Tighten the caps of the 2-way valve and 3-way valve to the stipulated torque.
- Remove the connection pipes (liquid side and gas side).

b. Removing the indoor and outdoor units

- Disconnect the pipes and connecting electric cables from between the indoor and outdoor units.
- Put capped flare nuts onto all of the pipe connections of the indoor and outdoor units, to make sure no dust or other foreign matter enters.
- Remove the indoor and outdoor units.

2. Installing the unit

Install the unit using new refrigerant piping. Follow the instructions in section 4.1 to evacuate the pipes connecting the indoor and outdoor units, and the pipes of the indoor unit, and check for gas leaks.

12.4.3. AC Units Replacement (Using Existing Refrigerant Piping)

When replacing an R410A AC unit with another R410A AC unit, you should re-flare the refrigerant piping. Even though the replacement AC unit uses the R410A, problems occur when, for example, either the AC unit maker or the refrigerating machine oil is different.

When replacing an R22 AC unit with an R410A AC unit, the following checks and cleaning procedures are necessary but are difficult to do because of the chemical characteristics of the refrigerating machine oil (as described in items c) and d) of section **About R410A Refrigerant**). In this case, you should use new refrigerant piping rather than the existing piping.

1. Piping check

Because of the different pressure characteristics of R22 and R410A, the design pressure for the equipment is 1.6 times different. The wall thickness of the piping must comply with that shown in Table 10, but this is not easy to check. Also, even if the thickness is correct, there may be flattened or bent portions midway through the piping due to sharp curves. Buried sections of the piping also cannot be checked.

2. Pipe cleaning

A large quantity of refrigerating machine oil (mineral oil) adheres to existing pipes due to the refrigeration cycle circulation. If the pipes are used just as they are for the R410A cycle, the capacity will be lowered due to the incompatibility of this oil with the R410A, or irregularities may occur in the refrigeration cycle. For this reason, the piping must be thoroughly cleaned, but this is difficult with the present technology.

12.4.4. Refrigerant Compatibility (Using R410A Refrigerant in R22 ACs and Vice Versa)

Do not operate an existing R22 AC with the new R410A refrigerant. Doing so would result in improper functioning of the equipment or malfunction, and might lead to a major accident such as an explosion in the refrigeration cycle. Similarly, do not operate an R410A AC with R22 refrigerant. The chemical reaction between the refrigerating machine oil used in R410A ACs and the chlorine that is contained in R22 would cause the refrigerating machine oil to degrade and lead to malfunction.

12.4.5. Recharging Refrigerant During Servicing

When recharging is necessary, insert the specified amount of new refrigerant in accordance with the following procedure.

1. Connect the charging hose to the service port of the outdoor unit.
2. Connect the charging hose to the vacuum pump adaptor. At this time, fully open the 2-way valve and 3-way valve.
3. Fully open the handle Lo of the manifold gauge, turn on the power of the vacuum pump and continue the vacuum process for at least one hour.
4. Confirm that the low pressure gauge shows a reading of -0.1 Mpa (-76 cmHg), then fully close the handle Lo, and turn off the

vacuum pump. Wait for 1-2 minutes, then check to make sure that the needle of the Low pressure gauge has not returned. See Fig. 13 for the remaining steps of this procedure.

- Set the refrigerant cylinder onto the electronic scale, then connect the hose the cylinder and to the connection port for the electronic scale. (1)(2)

Precaution:

Be sure to set up the cylinder for liquid charging. If you use a cylinder equipped with a siphon tube, you can charge the liquid without having to turn the cylinder around

- Remove the charging hose of the manifold gauge from the vacuum pump adaptor, and connect it to the connection port of the electronic scale. (2)(3)
- Open the valve of the refrigerant cylinder, then open the charging valve slightly and close it. Next, press the check valve of the manifold gauge and purge the air. (2)(4) (Watch the liquid refrigerant closely at this point.)
- After adjusting the electronic scale to zero, open the charging valve, then open the valve Lo of the manifold gauge and charge with the liquid refrigerant. (2)(5) (Be sure to read the operating instructions for the electronic scale.)
- If you cannot charge the stipulated amount, operate the unit in the cooling mode while charging a little of the liquid at a time (about 150 g/time as a guideline). If the charging amount is insufficient from one operation, wait about one minute, then use the same procedure to do the liquid charging again.

Precaution:

Never use the gas side to allow a larger amount of liquid refrigerant to be charged while operating the unit.

- Close the charging valve, and after charging the liquid refrigerant inside the charging hose, fully close the valve Lo of the manifold gauge, and stop the operation of the unit. (2)(5)
- Quickly remove the charging hose from the service port. (6) If you stop midway through, the refrigerant that is in the cycle will be discharged.
- After putting on the caps for the service port and operating valve, inspect around the caps for a gas leak. (6)(7)

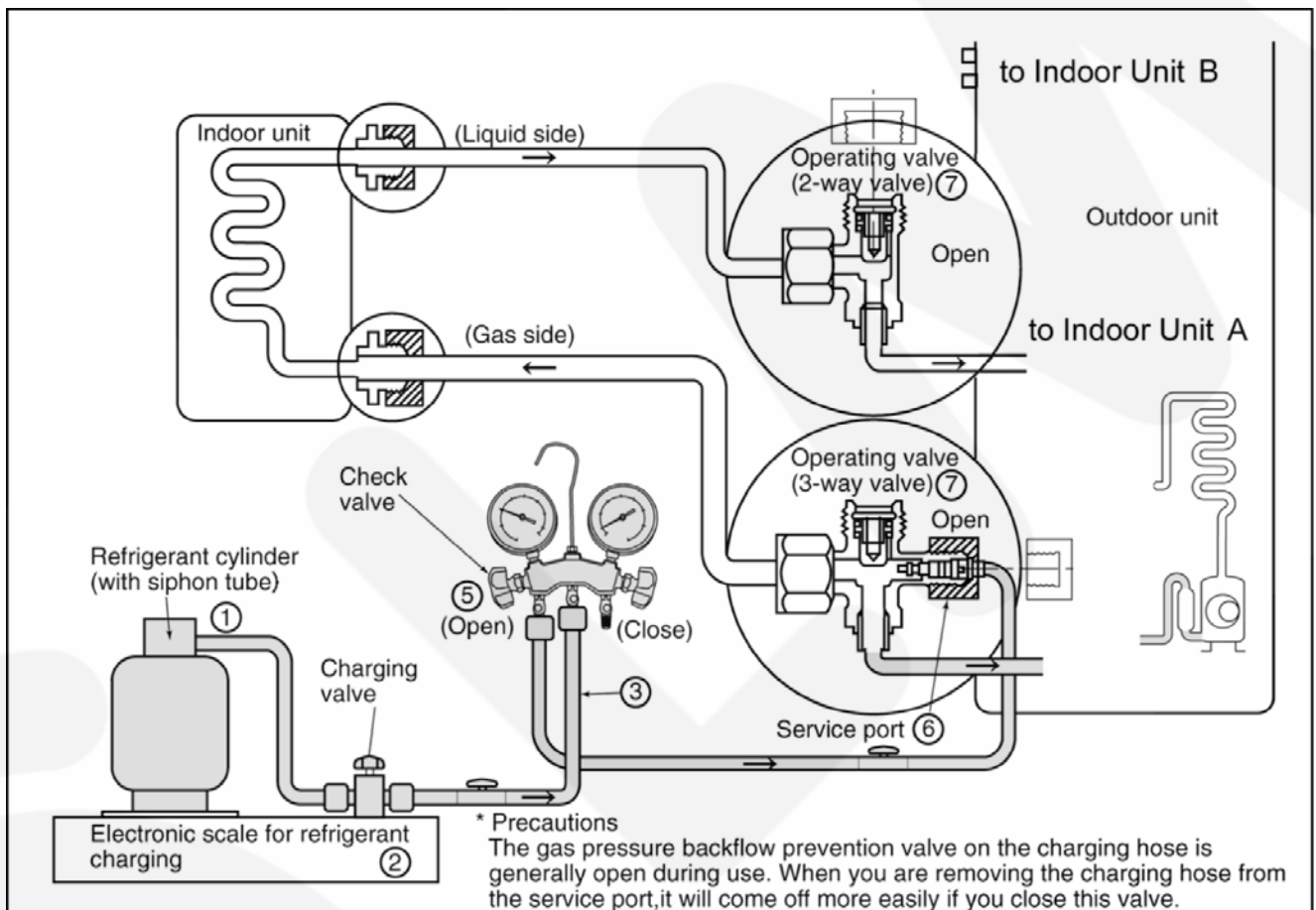

Fig. 13 Re-charging refrigerant

12.4.6. Brazing

As brazing requires sophisticated techniques and experiences, it must be performed by a qualified person.

In order to prevent the oxide film from occurring in the pipe interior during brazing, it is effective to proceed with brazing while letting dry nitrogen gas (N₂) flow.

<Brazing Method for Preventing Oxidation>

1. Attach a reducing valve to the nitrogen gas cylinder.
2. Apply a seal onto the clearance between the piping and inserted pipe for the nitrogen gas in order to prevent the nitrogen gas from flowing backward.
3. When the nitrogen gas is flowing, be sure to keep the piping end open.
4. Adjust the flow rate of nitrogen gas so that it is lower than 0.05 m³/h, or 0.02 MPa (0.2 kgf/cm²) by means of the reducing valve.
5. After taking the steps above, keep the nitrogen gas flowing until the piping cools down to a certain extent (i.e. temperature at which pipes are touchable with finger).
6. Completely remove the flux after brazing.

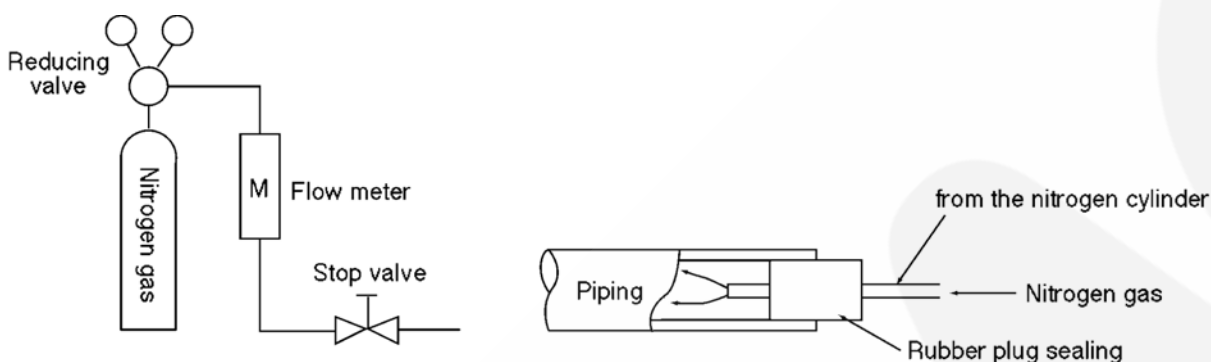

Fig. 14 Prevention of Oxidation during Brazing

Cautions during brazing

1. General Cautions

- a. The brazing strength should be high as required.
- b. After operation, airtightness should be kept under pressurized condition.
- c. During brazing do not allow component materials to become damaged due to overheating.
- d. The refrigerant pipe work should not become blocked with scale or flux.
- e. The brazed part should not restrict the flow in the refrigerant circuit.
- f. No corrosion should occur from the brazed part.

2. Prevention of Overheating

Due to heating, the interior and exterior surfaces of treated metal may oxidize. Especially, when the interior of the refrigerant circuit oxidizes due to overheating, scale occurs and stays in the circuit as dust, thus exerting a fatally adverse effect. So, make brazing at adequate brazing temperature and with minimum of heating area.

3. Overheating Protection

In order to prevent components near the brazed part from overheating damage or quality deterioration due to flame or heat, take adequate steps for protection such as (1) by shielding with a metal plate, (2) by using a wet cloth, and (3) by means of heat absorbent.

4. Movement during Brazing

Eliminate all vibration during brazing to protect brazed joints from cracking and breakage.

5. Oxidation Preventative

In order to improve the brazing efficiency, various types of antioxidant are available on the market. However, the constituents of these are widely varied, and some are anticipated to corrode the piping materials, or adversely affect HFC refrigerant, lubricating oil, etc. Exercise care when using an oxidation preventative.

12.4.7. Servicing Tips

The drier must also be replaced whenever replacing the refrigerant cycle parts. Replacing the refrigerant cycle parts first before replacing the drier. The drier is supplied in a vacuum pack. Perform brazing immediately after opening the vacuum pack, and then start the vacuum within two hours. In addition, the drier also needs to be replaced when the refrigerant has leaked completely. (Applicable for drier model only.)

13 Servicing Information

13.1. About Lead Solder (PbF)

DISTINCTION OF PbF P.C. BOARD

P.C. Boards (manufactured) using lead free solder will have a PbF stamp on the P.C. Board.

CAUTION

- Pb free solder has a higher melting point than standard solder; Typically the melting point is 50 - 70 °F (30 - 40 °C) higher. Please use a high temperature solder iron and set it to 700 ± 20 °F (370 ± 10 °C)
- Pb free solder will tend to splash when heated too high (about 1100 °F/ 600°C). If you must use Pb solder, please completely all of the Pb free solder on the pins or solder area before applying Pb solder. If this is not practical, be sure to heat the Pb free solder until it melts, before applying Pb solder.

13.2. Troubleshooting

Refrigeration cycle system

In order to diagnose malfunctions, make sure that there are no electrical problems before inspecting the refrigeration cycle. Such problems include insufficient insulation, problem with the power source, malfunction of a compressor and a fan.

The normal outlet air temperature and pressure of the refrigeration cycle depends on various conditions, the standard values for them are shown in the table to the right.

Normal Pressure and Outlet Air Temperature (Standard)

	Gas pressure MPa (kg/cm ² G)	Outlet Air Temperature (°C)
Cooling Mode	0.9 - 1.2 (9 - 12)	12 - 16
Heating Mode	2.3 - 2.9 (23 - 29)	36 - 45

Condition:

- Indoor fan speed; High
- Outdoor temperature 35 °C at cooling more and 7 °C at heating mode.
- Compressor operates at rated frequency

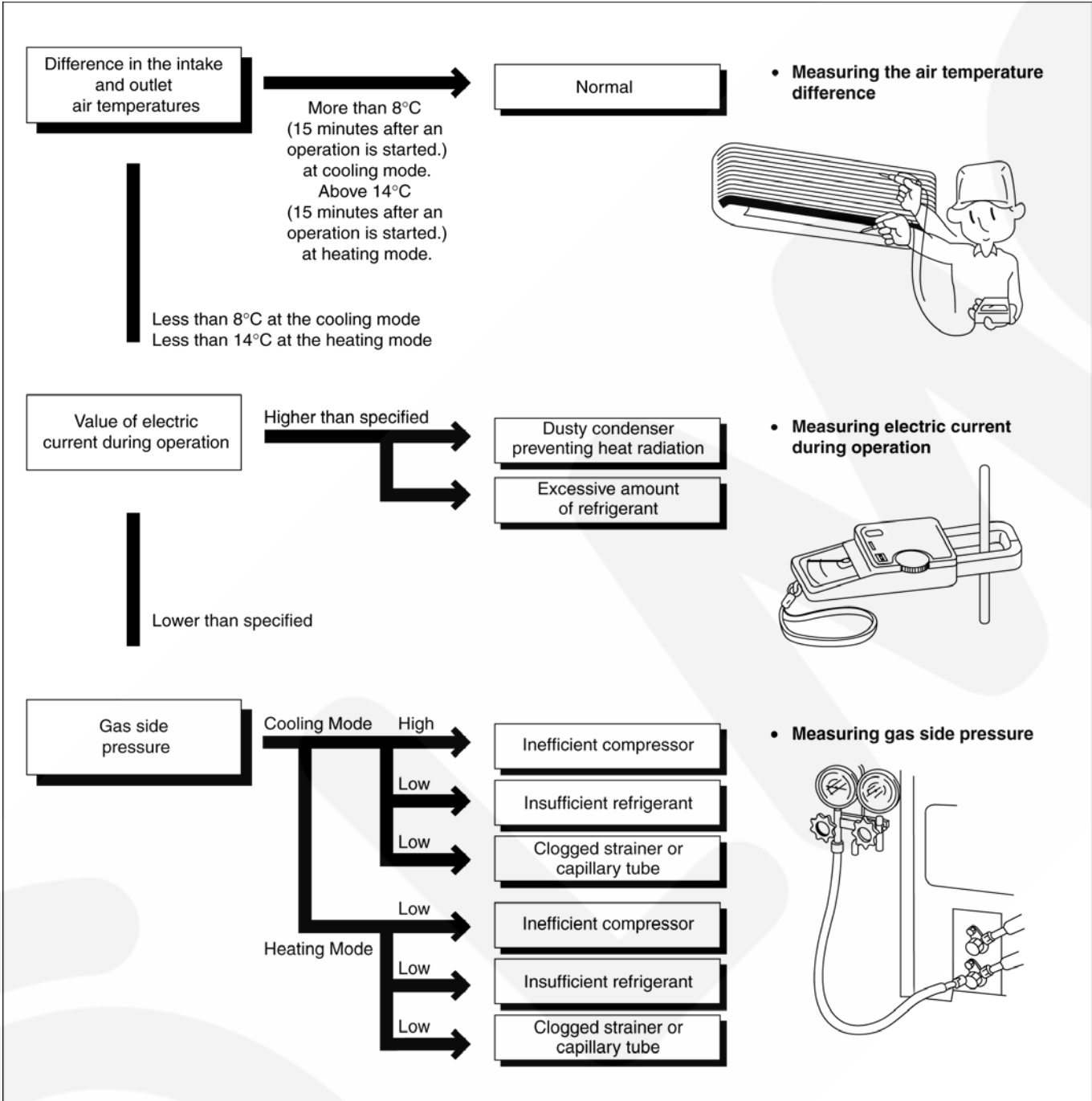

1. Relationship between the condition of the air conditioner and pressure and electric current

Condition of the air conditioner	Cooling Mode			Heating Mode		
	Low Pressure	High Pressure	Electric current during operation	Low Pressure	High Pressure	Electric current during operation
Insufficient refrigerant (gas leakage)	↘	↘	↘	↘	↘	↘
Clogged capillary tube or Strainer	↘	↘	↘	↗	↗	↗
Short circuit in the indoor unit	↘	↘	↘	↗	↗	↗
Heat radiation deficiency of the outdoor unit	↗	↗	↗	↘	↘	↘
Inefficient compression	↗	↘	↘	↗	↘	↘

- Carry on the measurements of pressure, electric current, and temperature fifteen minutes after an operation is started.

13.2.1. BREAKDOWN SELF DIAGNOSIS FUNCTION

13.2.1.1. Self Diagnosis Function (Three Digits Alphanumeric Code)

- Once abnormality has occurred during operation, the unit will stop its operation, and Timer or both Timer and ION LEDs blink. (The unit does not stop under ION abnormality.)
- Although Timer LED goes off when power supply is turned off, if the unit is operated under a breakdown condition, the LED will light up again.
- In operation after breakdown repair, the Timer LED will no more blink. The last error code (abnormality) will be stored in IC memory.

• To make a diagnosis

1. Timer LED or both timer and ION LEDs start to blink and the unit automatically stops the operation.
2. Press the CHECK button on the remote controller continuously for 5 seconds.
3. "- -" will be displayed on the remote controller display.
Note: Display only for "- -". (No transmitting signal, no receiving sound and no Power LED blinking.)
4. Press the "TEMP" ▲ or ▼ button on the remote controller. The code "H00" (no abnormality) will be displayed and signal will be transmitted to the main unit. The power LED lights up. If no abnormality is stored in the main unit memory, beep sound (3 beeps) will be heard.
5. Every press of the button (up or down) will increase abnormality numbers and transmit abnormality code signal to the main unit.
6. When the latest abnormality code on the main unit and code transmitted from the remote controller are matched, power LED will light up for 30 seconds and a beep sound (continuously for 4 seconds) will be heard. If no codes are matched, power LED will light up for 0.5 seconds and no sound will be heard.
7. The breakdown diagnosis mode will be canceled unless pressing the CHECK button continuously for 5 seconds or operating the unit for 30 seconds.
8. The LED will be off if the unit is turned off or the RESET button on the main unit is pressed.

• To display memorized error (Protective operation) status:

1. Turn power on.
2. Press the CHECK button on the remote controller continuously for 5 seconds.
3. "- -" will be displayed on the remote controller display.
Note: Display only for "- -". (No transmitting signal, no receiving sound and no Power LED blinking.)
4. Press the "TEMP" ▲ or ▼ button on the remote controller. The code "H00" (no abnormality) will be displayed and signal will be transmitted to the main unit. The power LED lights up. If no abnormality is stored in the memory, three beeps sound will be heard.
5. Every press of the button (up or down) will increase abnormality numbers and transmit abnormality code signal to the main unit.
6. When the latest abnormality code on the main unit and

code transmitted from the remote controller are matched, power LED will light up for 30 seconds and a beep sound (continuously for 4 seconds) will be heard. If no codes are matched, power LED will light up for 0.5 seconds and no sound will be heard.

7. The breakdown diagnosis mode will be canceled unless pressing the CHECK button continuously for 5 seconds or operating the unit for 30 seconds.
8. The same diagnosis can be repeated by turning power on again.

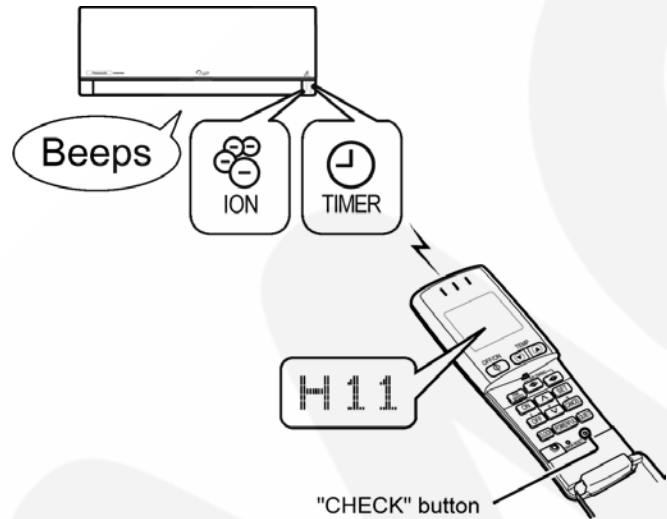

• To clear memorized error (Protective operation) status after repair:

1. Turn power on.
2. Press the AUTO button for 5 seconds (A beep receiving sound) on the main unit to operate the unit at Forced Cooling Operation mode.
3. Remove the battery cover of the remote controller and short-circuit the SET terminals. (A beep receiving sound)



• Temporary Operation (Depending on breakdown status)

1. Press the AUTO button (A beep receiving sound) on the main unit to operate the unit. (Remote control will become possible.)
2. The unit can temporarily be used until repaired.

Error Code	Operation	Temporary items
H23	Cooling	Emergency Operation with limited power
H27, H28	Cooling, Heating	
H26	Cooling, Heating	Emergency Operation without power limit.

13.2.1.2. Error Code Table

Diagnosis display	Abnormality / Protection control	Abnormality Judgement	Emergency operation	Primary location to verify
H11	Indoor / outdoor abnormal communication	> 1 min after starting operation	Indoor fan operation only	<ul style="list-style-type: none"> Internal / external cable connections Indoor / Outdoor PCB
H14	Indoor intake air temperature sensor abnormality	—	—	<ul style="list-style-type: none"> Intake air temperature sensor (defective or disconnected)
H15	Outdoor compressor temperature sensor abnormality	Continue for 5 sec.	—	<ul style="list-style-type: none"> Compressor temperature sensor (defective or disconnected)
H16	Outdoor Current Transformer open circuit	—	—	<ul style="list-style-type: none"> Outdoor PCB IPM (Power transistor) module
H19	Indoor fan motor mechanism lock	—	—	<ul style="list-style-type: none"> Indoor PCB Fan motor
H23	Indoor heat exchanger temperature sensor abnormality	Continue for 5 sec.	O (Cooling only)	<ul style="list-style-type: none"> Heat exchanger temperature sensor (defective or disconnected)
H26	Ionizer abnormality	—	—	<ul style="list-style-type: none"> Indoor PCB Ionizer
H27	Outdoor air temperature sensor abnormality	Continue for 5 sec.	O	<ul style="list-style-type: none"> Outdoor temperature sensor (defective or disconnected)
H28	Outdoor heat exchanger temperature sensor abnormality	Continue for 5 sec.	O	<ul style="list-style-type: none"> Outdoor heat exchanger temperature sensor (defective or disconnected)
H33	Indoor/Outdoor wrong connection	—	—	<ul style="list-style-type: none"> Indoor/Outdoor supply voltage
H97	Outdoor Fan Motor lock abnormality	—	—	<ul style="list-style-type: none"> Outdoor PCB Outdoor Fan Motor
H98	Indoor high pressure protection	—	—	<ul style="list-style-type: none"> Air filter dirty Air circulation short circuit
H99	Indoor heat exchanger anti-freezing protection	—	—	<ul style="list-style-type: none"> Insufficient refrigerant Air filter dirty
F11	Cooling / Heating cycle changeover abnormality	4 times occurrence within 30 minutes	—	<ul style="list-style-type: none"> 4-way valve V-coil
F91	Refrigeration cycle abnormality	2 times occurrence within 20 minutes	—	<ul style="list-style-type: none"> No refrigerant (3-way valve is closed)
F93	Outdoor compressor abnormal revolution	4 times occurrence within 20 minutes	—	<ul style="list-style-type: none"> Outdoor compressor
F95	Cool high pressure protection	4 times occurrence within 20 minutes	—	<ul style="list-style-type: none"> Outdoor refrigerant circuit
F96	IPM (power transistor) overheating protection	—	—	<ul style="list-style-type: none"> Excess refrigerant Improper heat radiation IPM (Power transistor)
F97	Outdoor compressor overheating protection	4 times occurrence within 10 minutes	—	<ul style="list-style-type: none"> Insufficient refrigerant Compressor
F98	Total running current protection	3 times occurrence within 20 minutes	—	<ul style="list-style-type: none"> Excess refrigerant Improper heat radiation
F99	Outdoor Direct Current (DC) peak detection	7 times occurrence continuously	—	<ul style="list-style-type: none"> Outdoor PCB IPM (Power transistor) Compressor

Note:

“O” - Frequency measured and fan speed fixed.

The memory data of error code is erased when the power supply is cut off, or press the Auto Switch until “beep” sound heard following by pressing the “RESET” button at remote controller.

Although operation forced to stop when abnormality detected, emergency operation is possible for certain errors (refer to Error Codes Table) by using remote controller or Auto Switch at indoor unit. However, the remote controller signal receiving sound is changed from one “beep” to four “beep” sounds.

13.3. Disassembly of Parts

13.3.1. Disassembly of Indoor Unit

13.3.1.1. Removal of the Front Grille

1. Pull the Front Panel up slowly.

Note: Open it by holding up the curve-in on the Grille.



Fig. 1

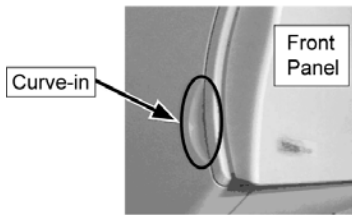

Fig. 2

2. Remove it inside by pressing Lever Arm with finger.

3. Remove the screw (one) in center part of the unit.

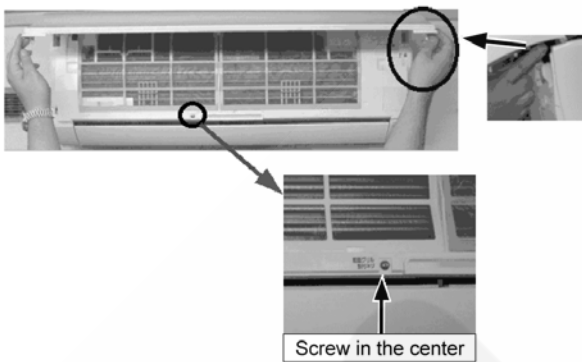

Fig. 3

4. Make the Vertical Louver level (horizontal).

5. Pull up the Screw Caps (2 parts) and remove the screws (two) inside.

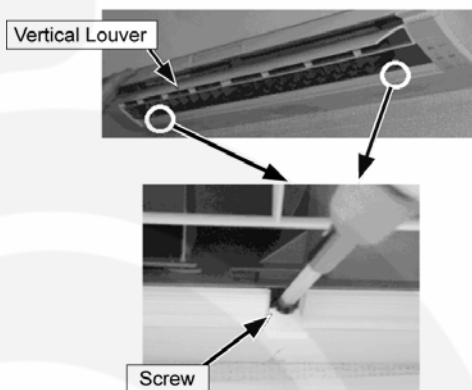

Fig. 4

6. Remove the Top Panel by pressing up the triangle marks (3 points) on it.

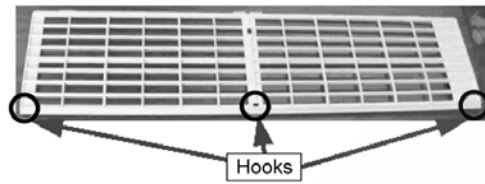

Fig. 5

7. Remove the Front Grille by pulling it up with taking notice of the Chassis Complete and the hooks (four).

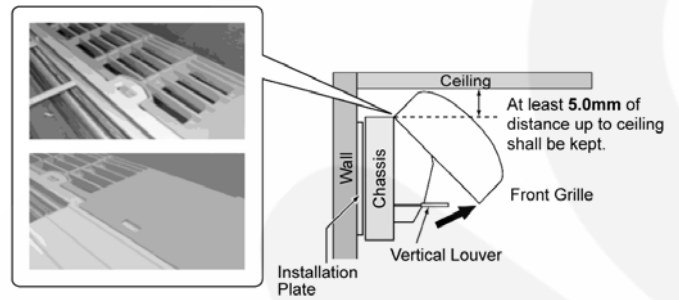

Fig. 6

13.3.1.2. Removal of Control Board Box

1. Remove the Front Grille according to the procedure 13.3.1.1.

2. Remove the screws (two) for the interconnect cable holder and the cable.

3. Remove the screws (two) fixing the Terminal Plate. (The Terminal Plate will be in the air.)

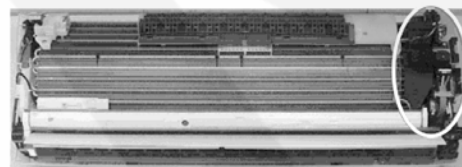

Fig. 7

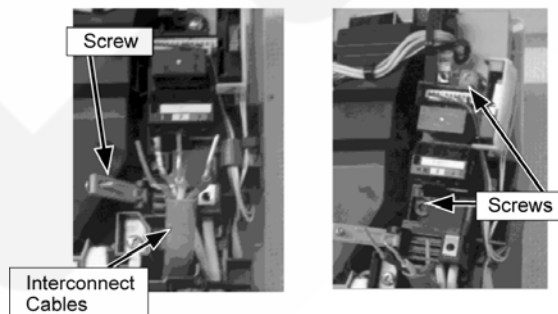

Fig. 8

4. Pull up the Control Board Box and remove the Control Board Cover A.

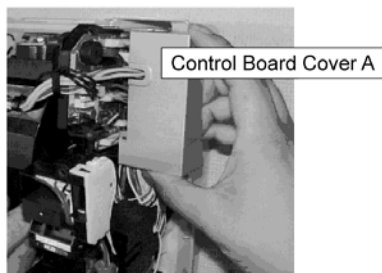

Fig. 9

5. Remove a variety of connectors and Terminals.

Wiring parts from the left side

- CN-CLN Cleaning Unit
- CN-TH Sensor Complete (Intake / Pipe Air Temp).
- Earth wire (yellow) Remove the screw (one).
- Terminal FG GRN (green)

Wiring parts from the bottom side

- Terminal Plate Connector
- CN-STM1 Air Swing Motor For Louver (Horizontal Louver)
- CN-STM2 Air Swing Motor For Louver (Vertical Louver)
- CN-STM3 Front Panel Motor
- CN-SUB1 Printed Circuit Board (SUB)
- CN-DISP Display & Receiver Unit
- CN-KANKI Ventilation Motor
- CN-FM Indoor Unit Fan Motor
- CN-CLNSW Micro Switch (Air Cleaning)
- Terminal Plate Connector

6. Remove the Control Board Box by pulling it out more.

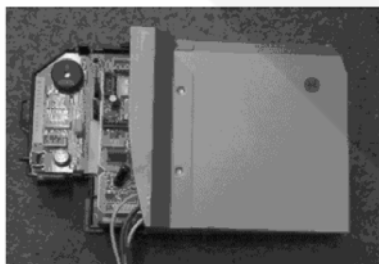

Fig. 10

13.3.1.3. Removal of Control Board

1. Remove the Front Grille according to the procedure 13.3.1.1.
2. Remove the Control Board Box according to the procedure 13.3.1.2.
3. Remove the Control Board Cover B.

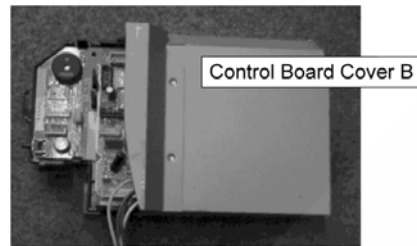

Fig. 11

4. Remove CN-DISP on the Display & Receiver Unit, CN-SUB1 on the PCB (SUB) and connector on the Terminal Plate.

5. Remove the Control Board Box (Black plastic chassis) by releasing the hooks (five).

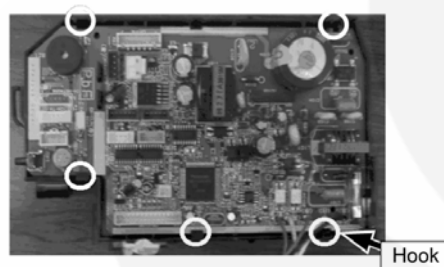

Fig. 12

6. Remove the PCB from the BOX.

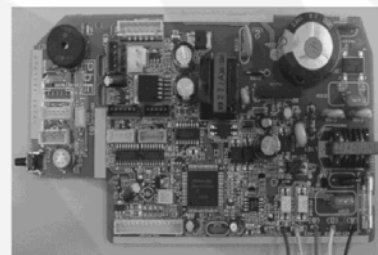

Fig. 13

13.3.1.4. Removal of Fan Motor and Cross-Flow Fan

1. Remove the Front Grille according to the procedure 13.3.1.1.
2. Remove the Control Board Box according to the procedure 13.3.1.2.
3. Remove the Discharge Grille. (Drain Hose)

Note: Pulling up the Discharge Grille a little can make the Drain Hose easy to be removed.

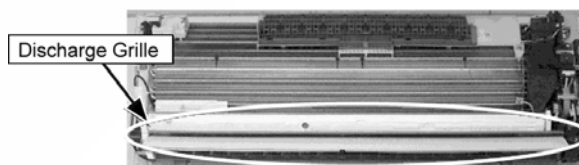

Fig. 14

4. Remove the Fan Motor Cover by removing the screws (four) on it.

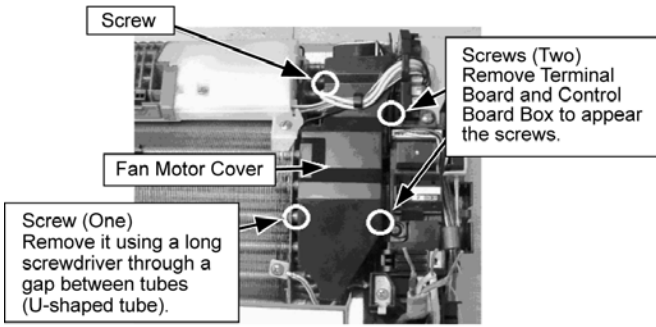

Fig. 15

5. Remove the screws (two) on the left side of the Heat Exchanger.

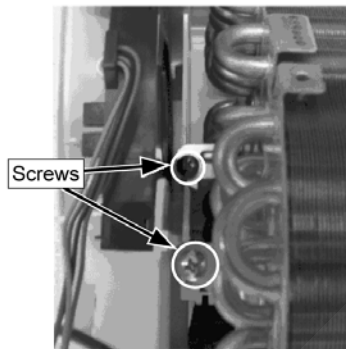

Fig. 16

6. Loosen the screw (one) between the Cross-Flow Fan and Fan Motor.

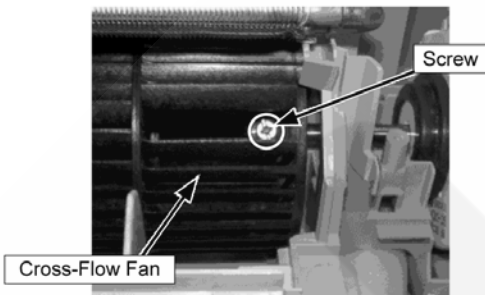

Fig. 17

7. Remove the Fan Boss by holding up the Heat Exchanger a little.

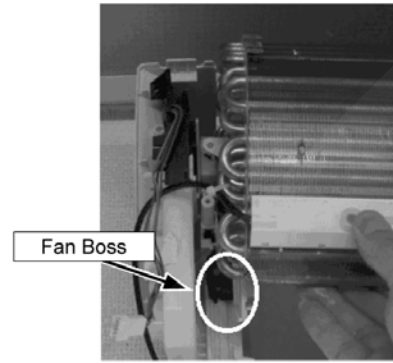

Fig. 18

8. Pull out the Cross-Flow Fan by holding up the left side of the Heat Exchanger.

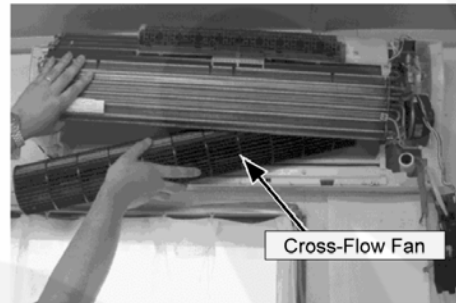

Fig. 19

9. Pull out the Fan Motor.

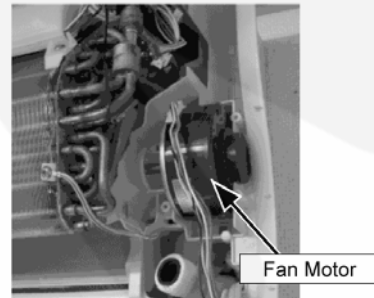

Fig. 20

Note for Reassembly Direction to which wire is pulled out.
 Be careful of the Chassis Complete not to be touched by the indoor fan motor connector. It may cause abnormal sound.

Adjust the position of each end of Cross-Flow Fan and Chassis Complete as shown in the Figure.

Fig. 21

13.3.1.5. Removal of Oxygen Discharge Outlet

1. Remove the Front Grille according to the procedure 13.3.1.1.
2. Remove the Oxygen Discharge Outlet from the Heat Exchanger and remove the Oxygen Tube by releasing the hooks (four) on the plastic part.

Note: The Oxygen Discharge Outlet is on the left side.

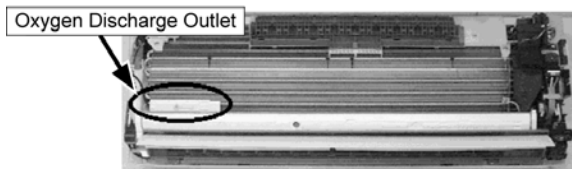

Fig. 22

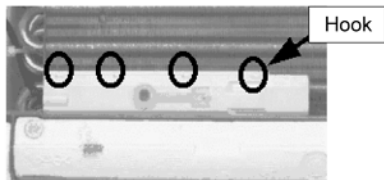

Fig. 23

13.3.1.6. Removal of Air Swing Motors for Vertical and Horizontal Louvers

1. Remove the Front Grille according to the procedure 13.3.1.1.
2. Remove the Discharge Grille.

Note: Pulling up the Discharge Grille a little can make the Drain Hose easy to be removed.

- The Air Swing Motor for Vertical Louver can be removed without removal of the Discharge Grille.

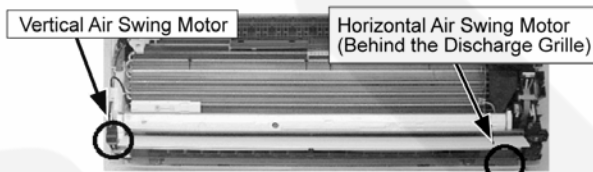

Fig. 24

3. Remove the Motors by removing the screws (one each) for the Motors and the cable connector.

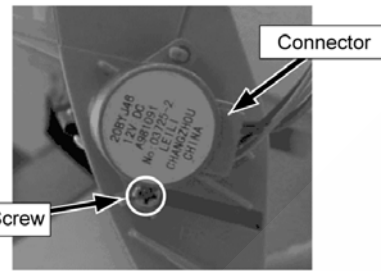

Fig. 25

13.3.1.7. Removal of Ventilation Motor

1. Remove the Front Grille according to the procedure 13.3.1.1.
2. Remove the Connector (white) for the Ventilation Motor and the screws (two).

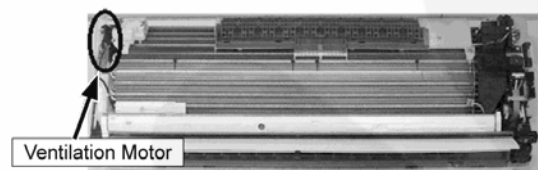

Fig. 26

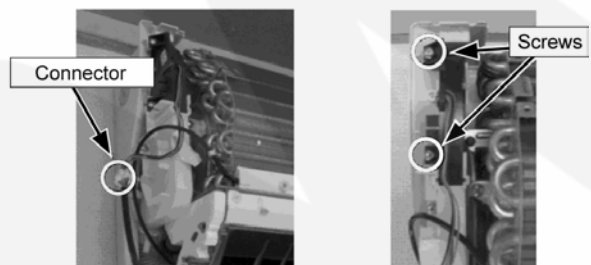

Fig. 27

3. Pulling out the Ventilation Motor by releasing the hook (one).

Note: The Fan Joint Duct Part under the Ventilation Motor can not be removed. Remove the Indoor unit from the Chassis Complete for servicing.

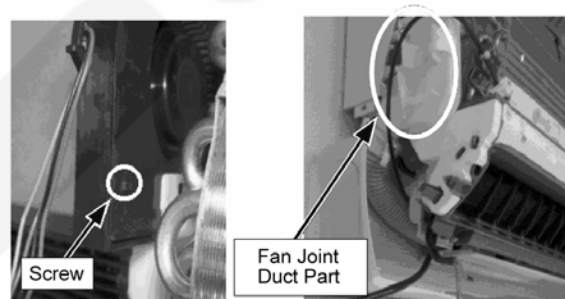

Fig. 28

13.3.1.8. Removal of Front Panel Motor

1. Remove the Front Grille according to 13.3.1.1.
2. Remove the Motor by removing the screw (one). Be careful of the Heat Exchanger Fins.

Note: Replace a plastic part of the Front Panel Motor with a new plastic complete part for servicing in order to avoid loss of the parts such as gear although it can be disassembled with a precision screwdriver.

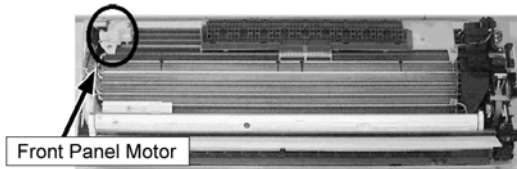

Fig. 29

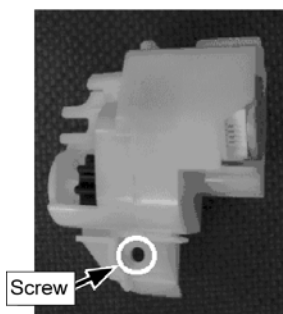

Fig. 30

13.3.1.9. Removal of Ionizer

Remove the Ionizer from the Heat Exchanger by unscrewing the screw (One) on the lower right.

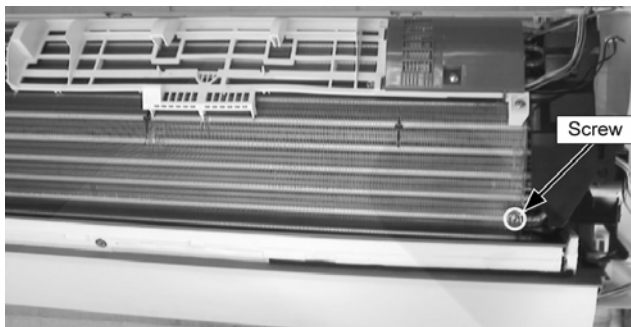

Fig. 31

13.3.2. Disassembly of Outdoor Unit

⚠ WARNING

Electric parts in Outdoor Unit (Control Cover inside) contain High Voltage by booster capacitor. Make sure to discharge it completely before servicing in order to prevent electric shock.

13.3.2.1. Removal of Cabinet Top Plate and Cabinet Front Plate

1. Remove the screws (three: two on the right side and one on the left side) and the Cabinet Top Plate.
2. Remove the screws (six: three on the upper side and another three on the lower side) on the Cabinet Front Plate.

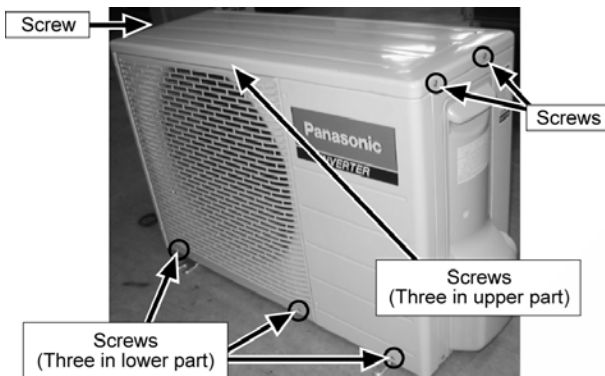

Fig. 1

3. Release the hooks (four: two on the right and another two on the left) of the Cabinet Front Plate and remove the Front Plate by holding it up a little.

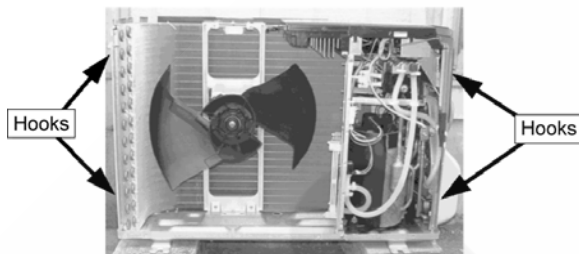

Fig. 2

13.3.2.2. Removal of Control Cover and Terminal Cover

1. Remove the Front Grille according to the procedure 13.3.1.2.
2. Remove the screw (one) on the Control Cover and remove it by sliding it downward.

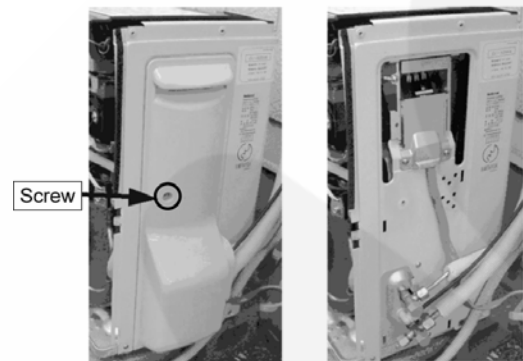

Fig. 3

3. Remove the Terminal Cover by removing the screws (two) and releasing the hooks (two).

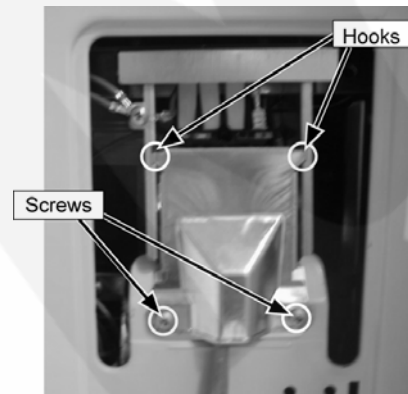

Fig. 4

13.3.2.3. Removal of Control Box

1. Remove the Cabinet Top Plate and Cabinet Front Plate according to 13.3.2.1.
2. Remove the Control Cover and Terminal Cover according to 13.3.2.2.
3. Remove the Control Board by releasing the hooks (four: two each on the right and left).

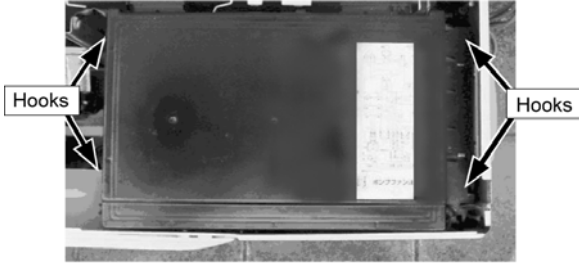

Fig. 5

4. Remove the screw (one) fixing the Control Box.

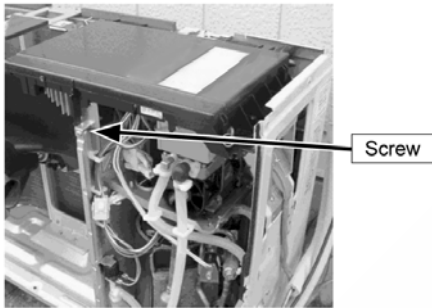

Fig. 6

5. Remove a variety of connectors and Terminals.

- Compressor cables (red, blue and yellow)
..... Remove the Connector (white).
- CN-HOT 4-way Valve
- CN-FM1 Outdoor Fan Motor
- CN-STM Expansion Valve
- CN-TH
..... Sensor Complete (Outdoor Air/Pipe Temp.)
- CN-DIS
..... Sensor Complete (Discharge Air Temperature)
- CN-COLD Oxygen 2-way Valve
- Vacuum pump Cables (red, white and black)
..... remove the Connector white).
- Reactor Connectors (two)

6. Remove the interconnect cables and the Earth Wire (one screw).

- Interconnect cables (red, white and black)
..... Disconnect them from the Terminals.
- The earth terminal (yellow-green)
..... Remove it by unscrewing. (one screw)
- Remove the screws (two) fixing the Terminal part and

the Cabinet Side Plate.

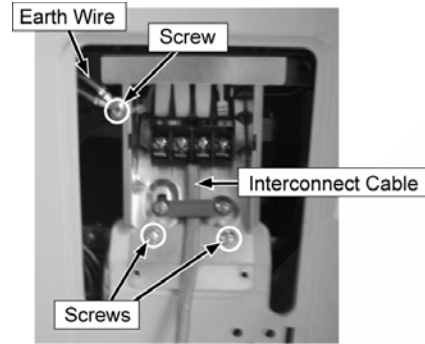

Fig. 7

7. Remove the Control Box from the unit by holding it up.

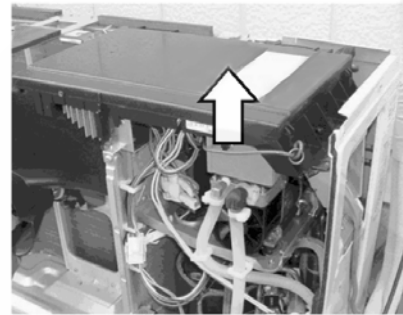

Fig. 8

13.3.2.4. Removal of Control Board

1. Remove the Cabinet Top Plate and Cabinet Front Plate according to 13.3.2.1.
2. Remove the Control Cover and Terminal Cover according to 13.3.2.2.
3. Remove the Control Box according to 13.3.2.3.
4. Disconnect the Control Terminals (Four cables).



Fig. 9

5. Place the Control Box reversely and remove the screws (two) on the both sides of the Control Box B (for Terminal Plate).

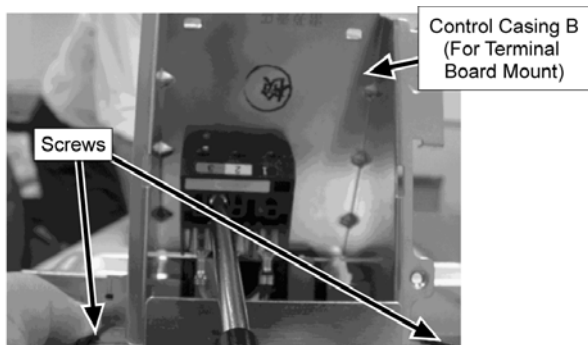

Fig. 10

6. Release the hooks (four) on the Control Box A (Lower Control PCB Cover).

Note: Be careful of hanging-up of connectors or wiring cables such as the earth wire when the Box A is removed.

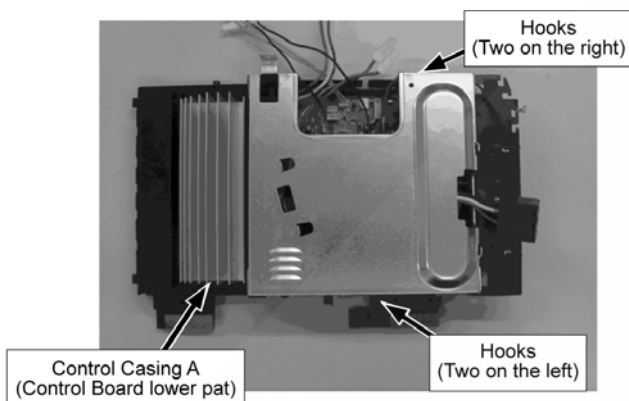

Fig. 11

7. For the Control Board, replacement is made together with the Control Box.

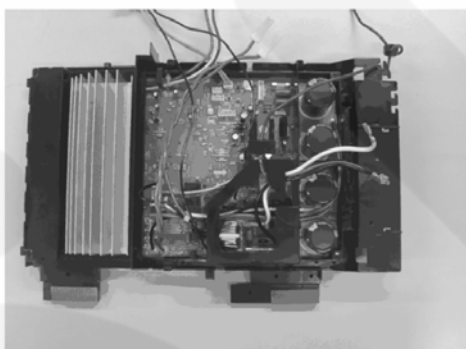

Fig. 12

- Replacement of the Outdoor Control PCB should be made as a whole unit due to silicon pasting, etc. although it can be separated PCB part from Control BOX plastic part by removing the screws (six) on the PCB.

13.3.2.5. Removal of Propeller Fan and Fan Motor

1. Remove the Cabinet Top Plate and Cabinet Front Plate according to 13.3.2.1.
2. Remove the Control Box by releasing the hooks (four: two each on the both sides).



Fig. 13

3. Remove only the Connector for the CN-FM1 (Outdoor unit Fan Motor).
4. Remove the Propeller Fan by turning the nut in the center of the fan clockwise.

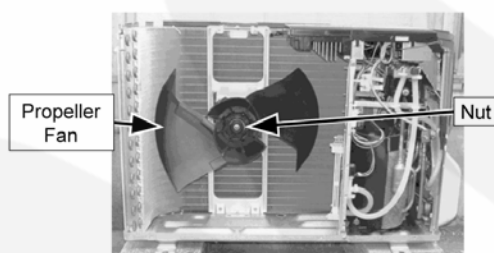

Fig. 14

5. Remove the Fan Motor by loosening the screw (four).

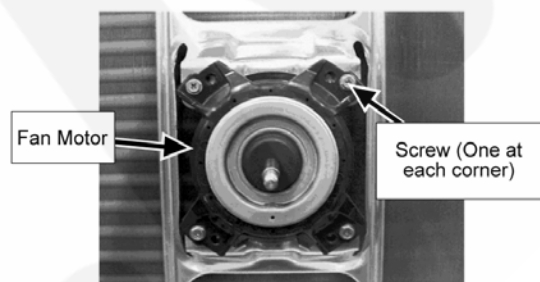

Fig. 15

Note: Adjust the location of the Boss in the center of the Propeller and the matching groove on the shaft of the Motor when putting them together.

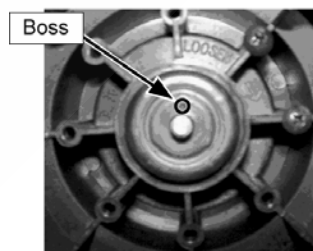

Fig. 16

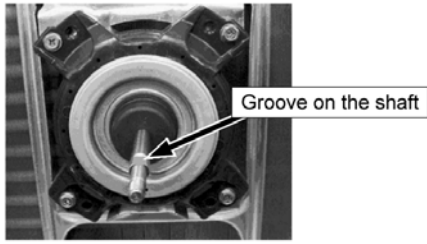

Fig. 17

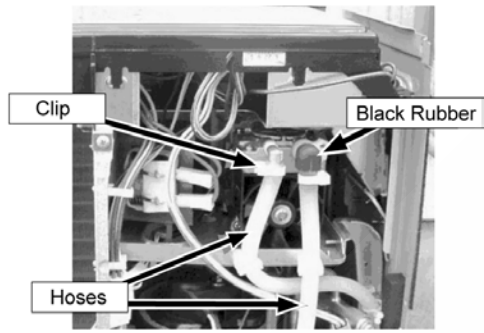

Fig. 20

13.3.2.6. Removal of Vacuum Pump

1. Remove the Cabinet Top Plate and Cabinet Front Plate according to 13.3.2.1.
2. Remove the Control Cover and Terminal Cover according to 13.3.2.2.
3. Remove the screws (two) fixing Terminal part and the Cabinet Side Plate.

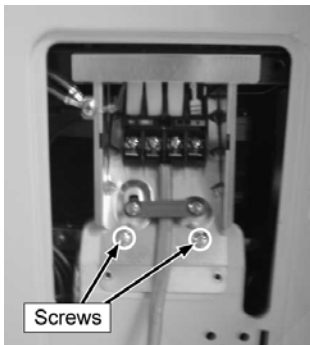

Fig. 18

- Connect two hoses correctly when reassembling the Vacuum Pump. Incorrect connection may cause failure.

7. Remove the screws (three) for the Vacuum Pump.

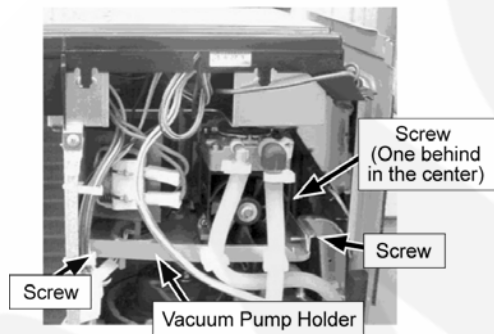

Fig. 21

4. Remove the Cabinet Side Plate by removing the screws (five).

- A screw of among the five is under the back side of the Outdoor unit.

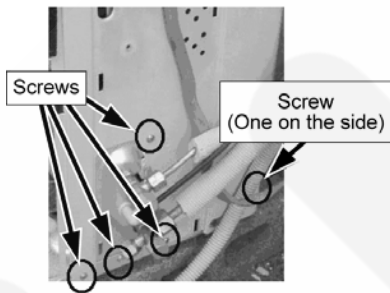

Fig. 19

8. Remove the Vacuum Pump by holding up the backside of the Vacuum Pump Holder a little and pulling it in with inclined to the left side.

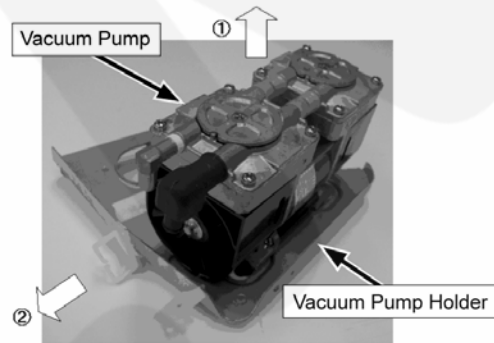

Fig. 22

5. Disconnect the cable of the Vacuum Pump from the Connector (white).
6. Disconnect the hose from the Vacuum Pump by loosening the clip with tools such as pliers.

Note: Do not remove the connecting materials (Black rubber) on the intake side from the hose.

14 Technical Data

14.1. Operation Characteristics

CS-HE9DKE CU-HE9DKE

• Cooling Characteristic

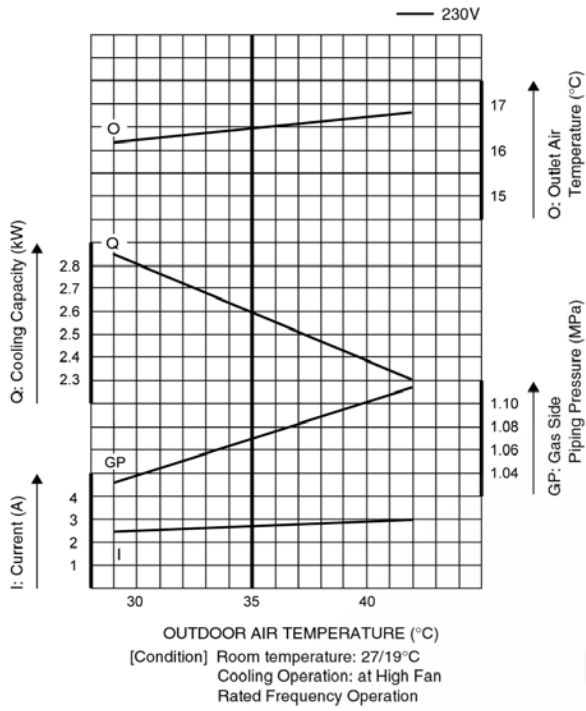

• Piping Length Characteristic (Cooling)

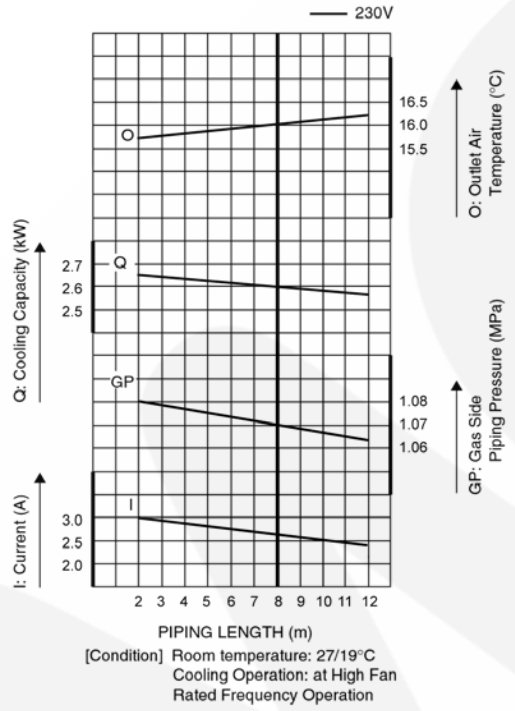

• Heating Characteristic

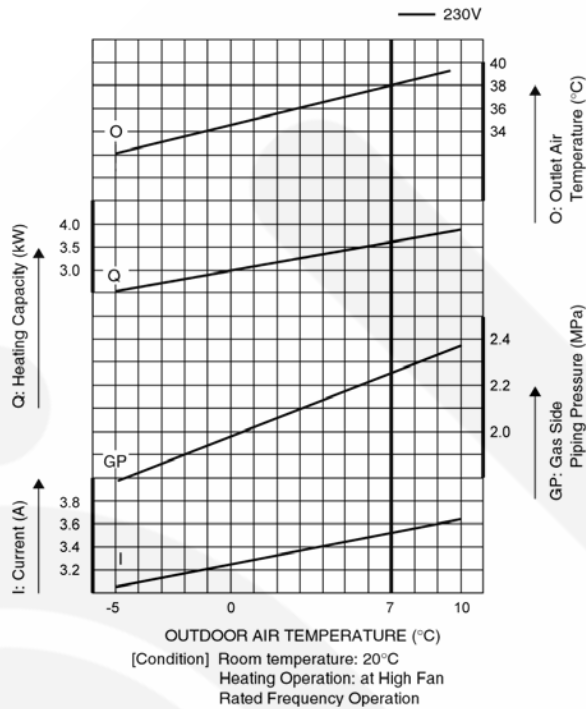

• Piping Length Characteristic (Heating)

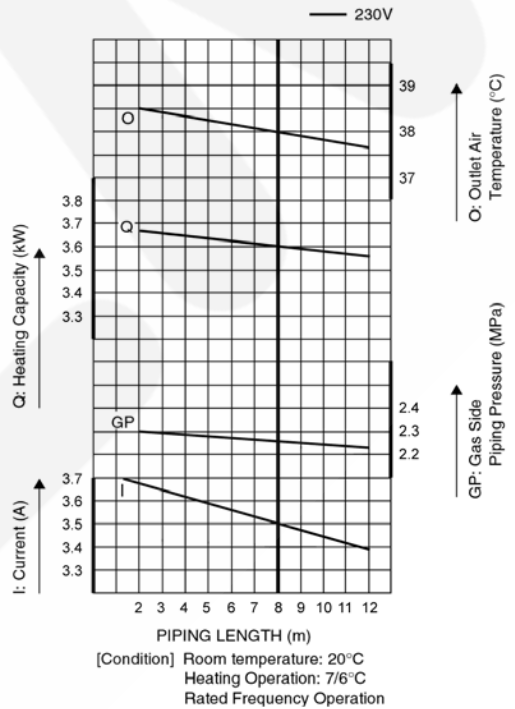

CS-HE12DKE CU-HE12DKE

• Cooling Characteristic

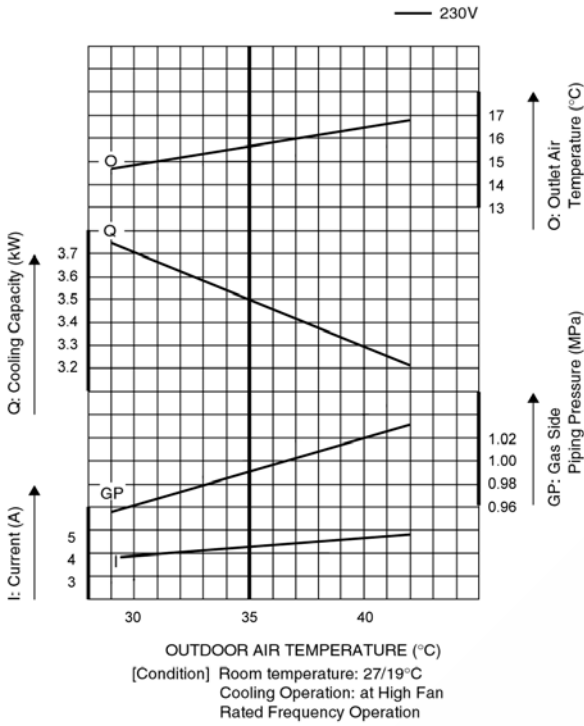

• Piping Length Characteristic (Cooling)

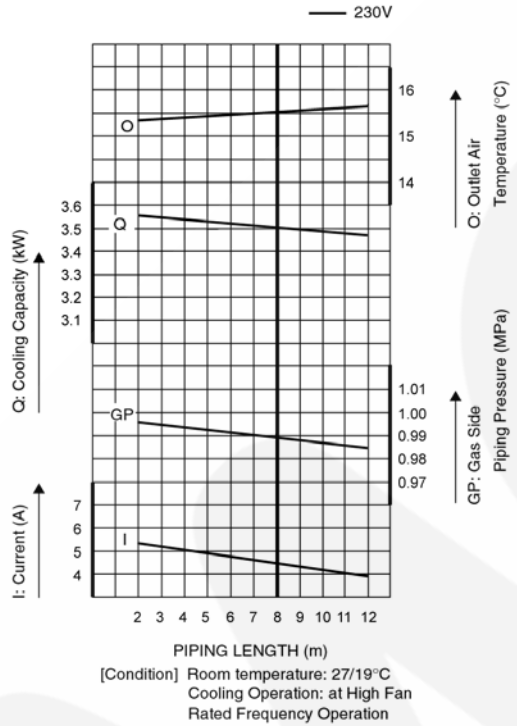

• Heating Characteristic

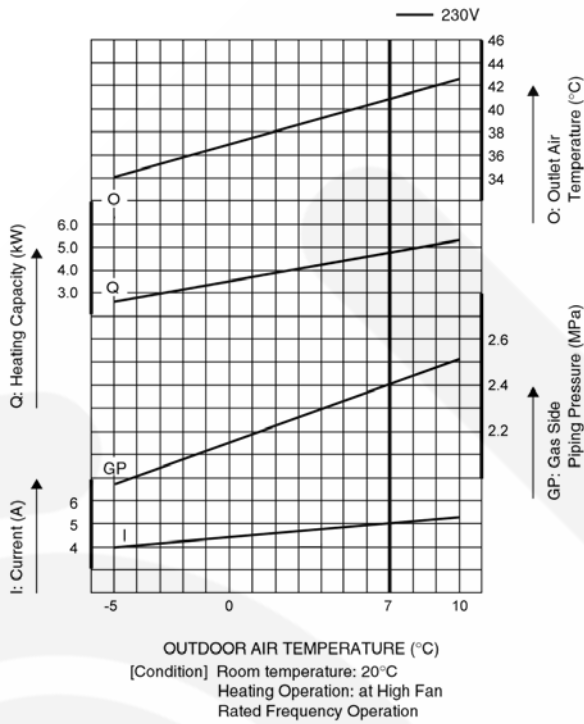

• Piping Length Characteristic (Heating)

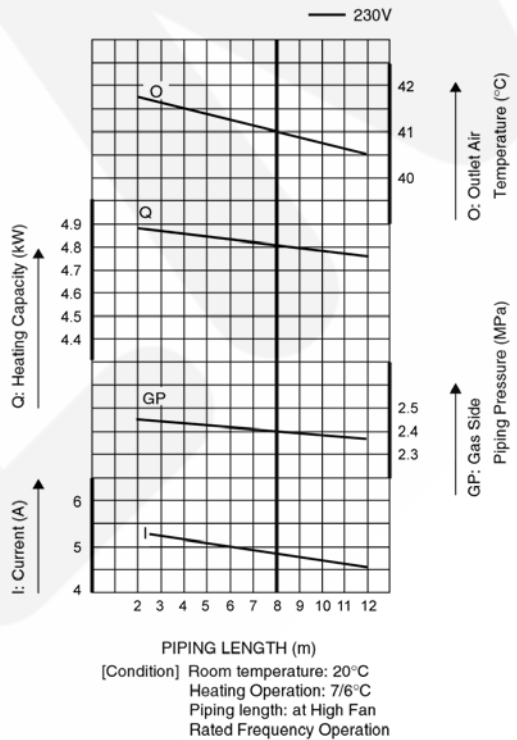

14.2. Sensible Capacity Chart

CS-HE9DKE CU-HE9DKE

230V	Outdoor Temp. (°C)											
Indoor wet bulb temp.	30			35			40			46		
	TC	SHC	IP	TC	SHC	IP	TC	SHC	IP	TC	SHC	IP
17.0°C	2.58	2.33	0.46	2.41	2.24	0.50	2.24	2.14	0.54	2.04	2.03	0.59
19.0°C				2.60		0.51						
19.5°C	2.83	2.44	0.47	2.65	2.34	0.51	2.46	2.25	0.55	2.24	2.14	0.60
22.0°C	3.09	2.52	0.49	2.88	2.43	0.53	2.68	2.34	0.57	2.44	2.24	0.62

CS-HE12DKE CU-HE12DKE

230V	Outdoor Temp. (°C)											
Indoor wet bulb temp.	30			35			40			46		
	TC	SHC	IP	TC	SHC	IP	TC	SHC	IP	TC	SHC	IP
17.0°C	3.42	2.86	0.77	3.20	2.75	0.84	2.97	2.64	0.90	2.70	2.51	0.97
19.0°C				3.45		0.85						
19.5°C	3.76	3.01	0.79	3.51	2.89	0.85	3.27	2.78	0.92	2.97	2.64	0.99
22.0°C	4.10	3.12	0.80	3.83	3.00	0.87	3.56	2.89	0.94	3.24	2.75	1.01

15 Exploded View and Replacement Parts List

15.1. Exploded View (Indoor Unit)

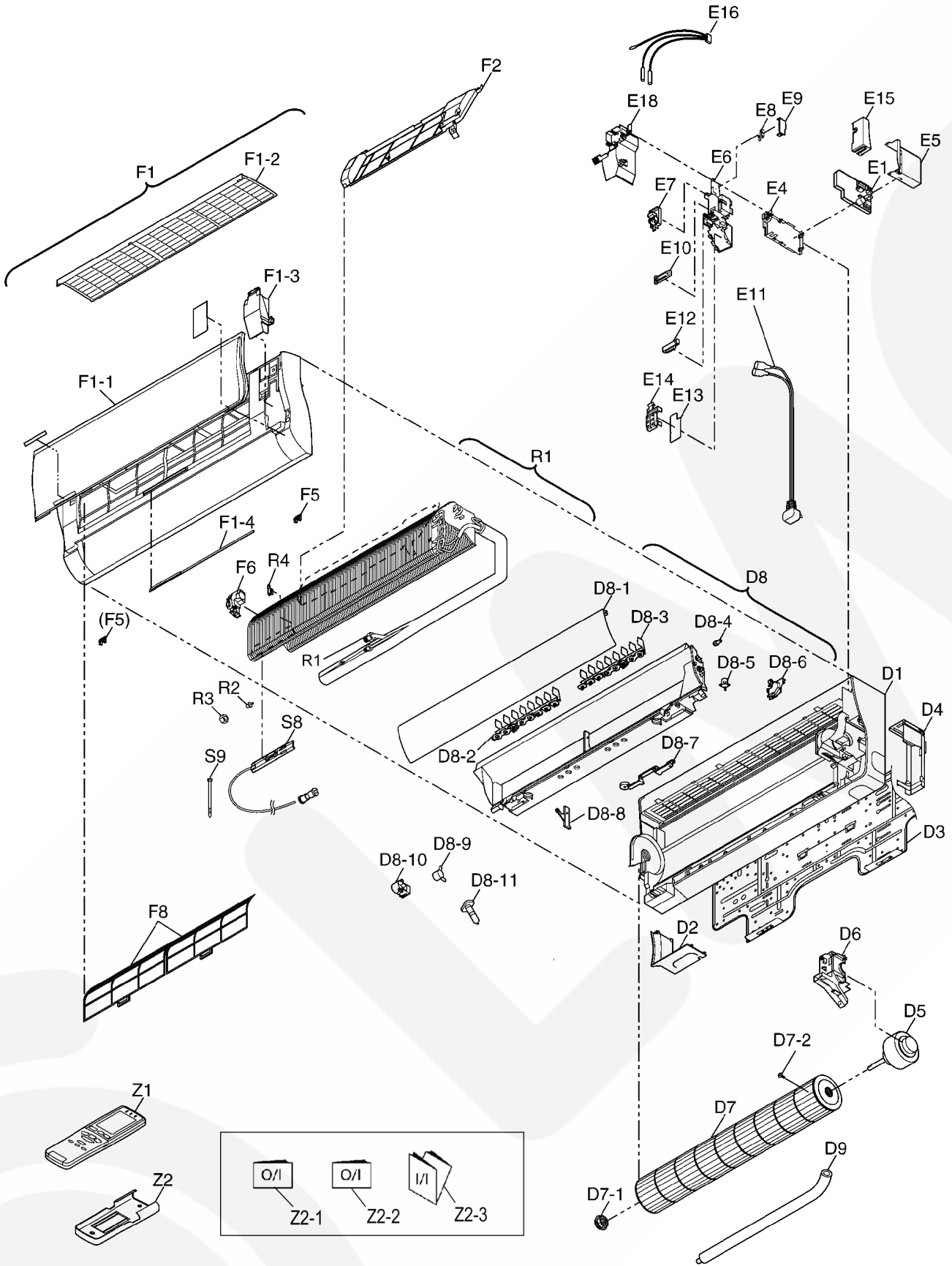

Note:
The above exploded view is for the purpose of parts disassembly and replacement.

The non-numbered parts are not kept as standard service parts.

15.2. Replacement Parts List (Indoor Unit)

<Models: CS-HE9DKE / CS-HE12DKE>

REF. NO.	PART NAME & DESCRIPTION	QTY.	CS-HE9DKE	CS-HE12DKE	REMARKS
D1	CHASSY COMPLETE	1	CWD50C50C1430	←	
D2	L-PLATE	1	CWD601065	←	
D3	INSTALLATION PLATE	1	CWH361054	←	
D4	PARTICULAR PLATE	1	CWD911316	←	
D5	FAN MOTOR	1	ARW41X8P30AC	←	
D6	FAN MOTOR PLATE	1	CWD911313	←	
D7	CROSS FLOW FAN	1	CWH02C1024	←	
D7-1	BERING ASS'Y	1	CWH64K1005	←	
D7-2	SCREW - CROSS FLOW FAN	1	CWH4580304	←	
D8	DISCHARGE GRILLE COMPLETE	1	CWE20C2430	←	
D8-1	VERTICAL VANE	1	CWE241129	←	
D8-2	HORIZONTAL VANE (LEFT)	1	CWE24C1054	←	
D8-3	HORIZONTAL VANE (RIGHT)	1	CWE24C1055	←	
D8-4	CAP (FOR VERTICAL VANE BERING)	1	CWH52160	←	
D8-5	AIR SWING MOTOR (HORIZONTAL VANE)	1	CWA981107J	←	
D8-6	PROTECTION COVER (RIGHT)	1	CWH811018	←	
D8-7	GEAR (FOR HORIZONTAL VANE)	1	CWH68C1017	←	
D8-8	FULCRUM	1	CWH621031	←	
D8-9	AIR SWING MOTOR (VERTICAL VANE)	2	CWA981105J	←	
D8-10	PROTECTION COVER (LEFT)	1	CWH811019	←	
D8-11	CAP (DRAIN CAP)	1	CWH521091	←	
D9	DRAIN HOSE	1	CWH851107	←	
E1	ELECTRONIC CONTROLLER - MAIN	1	CWA73C1870	CWA73C1871	
E4	CONTROL COVER - 1	1	CWH131163	←	
E5	CONTROL COVER - 3	1	CWH13K1010	←	
E6	CONTROL BOARD BOX	1	CWH121009	←	
E7	TERMINAL BOARD COMPLETE	1	CWA28C2192	←	
E8	SWITCH (MICRO SW)	1	KOKABF000013	←	
E9	SWITCH HOLDER	1	CWD932308	←	
E10	CORD HOLDER	1	CWD77002	←	
E11	POWER SUPPLY CORD	1	CWA20C2441	←	
E12	ELECTRONIC CONTROLLER (SUB)	1	CWA743835	←	
E13	ELECTRONIC CONTROLLER (RECEIVER, DISPLAY)	1	CWA743834	←	
E14	HOLDER - ELECTRONIC CONTROLLER (RECEIVER, DISPLAY)	1	CWD932309	←	
E15	CONTROL COVER - 2	1	CWH131165	←	
E16	SENSOR COMPLETE (INTAKE AIR, PIPE)	1	CWA50C2286	←	
E18	ANTI-WATER SPLASHING PLASTIC	1	CWD911317	←	
F1	FRONT GRILLE COMPLETE	1	CWE11C3293XA	←	
F1-1	FRONT PANEL	1	CWE22C1206XA	←	
F1-2	TOP INTAKE GRILLE	1	CEW221090	←	
F1-3	GRILLE DOOR	1	CWE141060XA	←	
F1-4	OXYGEN MONITOR	1	CWE39C1085	←	
F2	ION GENERATOR	1	CWH94C0006	←	
F5	CAP (SCREW CAP)	2	CWH521088	←	
F6	GEAR (FRONT PANEL MOTOR)	1	CWH68C1021	←	
F8	AIR FILTER	2	CWD001163	←	
R1	EVAPORATOR	1	CWB30C1725	CWB30C1729	
R2	FLARE NUT (1/4")	1	CWT25086 (1/4")	←	
R3	FLARE NUT (3/8")	1	CWT25087 (3/8")	CWT25096 (1/2")	
R4	ANTI-FITTING PLASTIC	1	CWD932334	←	
S8	BOX	3	CWD76C1015	←	
S9	BELT	1	CWH88000	←	
Z1	REMOTE CONTROL COMPLETE	1	CWA75C2688X	←	
Z2	REMOTE CONTROL HOLDER	1	CWH361046	←	
Z2-1	OPERATING INSTRUCTIONS	1	CWF564743	←	
Z2-2	OPERATING INSTRUCTIONS	1	CWF564897	←	
Z2-3	INSTALLATION INSTRUCTIONS	1	CWF564897	←	

(Note)

- All parts are supplied from ACD, Japan.
- "O" marked parts are recommended to be kept in stock.

15.3. Exploded View (Outdoor Unit)

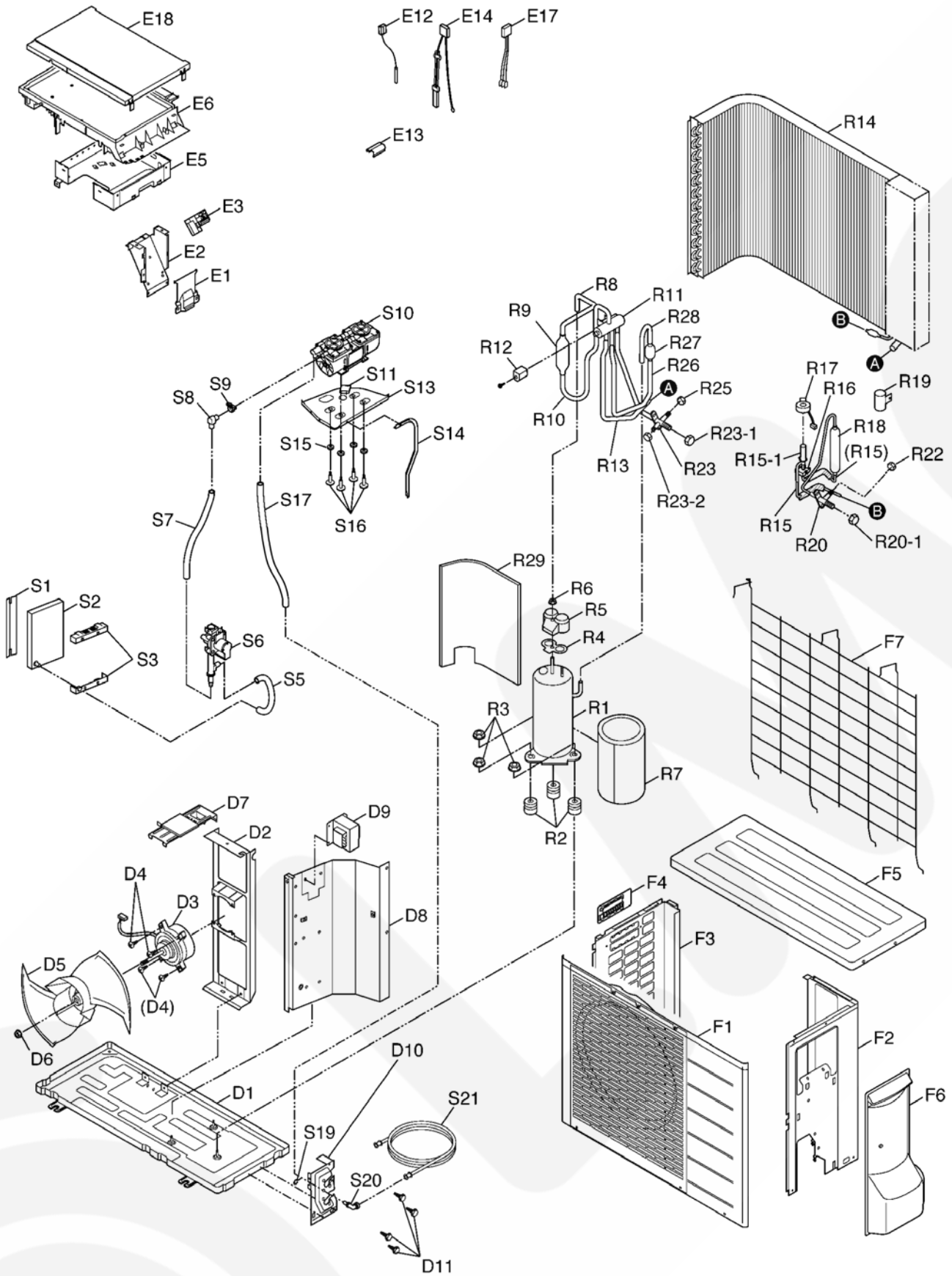

Note:
 The above exploded view is for the purpose of parts disassembly and replacement.
 The non-numbered parts are not kept as standard service parts.

15.4. Replacement Parts List (Outdoor Unit)

<Models: CU-HE9DKE / CU-HE12DKE>

REF NO.	DESCRIPTION & NAME	QTY.	CU-HE9DKE	CU-HE12DKE	REMARKS
D1	CHASSY COMPLETE	1	CWD50K2103	←	
D2	FAN MOTOR BRACKET	1	CWD541021	←	
D3	FAN MOTOR	1	ARW44X8P40AC	←	
D4	SCREW - FAN MOTOR MOUNT	4	CWH55252J	←	
D5	PROPELLER FAN	1	CWH03K1014	←	
D6	NUT - PROPELLER FAN	1	CWH561034J	←	
D7	FAN MOTOR MOUNT PLATE (UPPER)	1	CWMD910001X2	←	
D8	SOUND PROOF MATERIAL	1	CWH151076	←	
D9	REACTOR	1	G0A193M00003	G0A193M00002	
D10	HOLDER - COUPLING	1	CWH351029	←	
D11	SCREW -COUPLING MOUNT	4	XVG6B14VW	←	
E1	CONTROL COVER (TERMINAL PLATE COVER)	1	CWH131244X	←	
E2	CONTROL PLATE CASING (TERMINAL BOARD)	1	CWH102284	←	
E3	TERMINAL BOARD	1	CWA38K1121	←	
E5	CONTROL BOARD (ELECTRONIC CONTROLLER - LOWER)	1	CWH102244X	←	
E6	ELECTRONIC CONTROLLER	1	CWA73C1819R	CWA73C1820R	
E12	SENSOR COMPLETE (DISCHARGE TEMP.)	1	CWA50C2281	←	
E13	SENSOR HOLDER (DISCHARGE TEMP.)	1	CWH321025	←	
E14	SENSOR COMPLETE (OUTDOOR, PIPE TEMP.)	1	CWA50C2219	←	
E17	LEAD WIRE COMPLETE (COMPRESSOR)	1	CWA67C5736	←	
E18	CONTROL BOARD COVER	1	CWH131206XF	←	
F1	CABINET FRONT PLATE	1	CWE06C1126	←	
F2	CABINET SIDE PLATE (RIGHT)	1	CWE04C1064	←	
F3	CABINET SIDE PLATE (LEFT)	1	CWE041132	←	
F4	HANDLE	1	CWE161013	←	
F5	CABINET TOP PLATE	1	CWE031053	←	
F6	CONTROL BOARD COVER (2-, 3-WAY VALVE COVER)	1	CWMH13C0002	←	
F7	WIRE NET	1	CWD041046	←	
R1	COMPRESSOR	1	CWB092332	←	
R2	ANTI-VIBRATION BUSHING (COMPRESSOR)	3	CWH501022	←	
R3	NUT - COMPRESSOR MOUNT	3	CWH56000J	←	
R4	RUBBER GASKET (COMPRESSOR)	1	CWH7070603	←	
R5	TERMINAL COVER (COMPRESSOR)	1	CWH17006	←	
R6	NUT - TERMINAL COVER	1	CWH7080300J	←	
R7	SOUND PROOF MATERIAL (COMPRESSOR)	1	CWG302303	←	
R8	MULTI BEND TUBE (COMPRESSOR - LIQUID RECEIVER)	1	CWT334002	←	
R9	LIQUID RECEIVER (MULTI BEND TUBE - MULTI BEND TUBE)	1	CWB14011	←	
R10	MULTI BEND TUBE (LIQUID RECEIVER - 4-WAY VALVE)	1	CWT333570	←	
R11	4-WAY VALVE	1	CWB001037J	←	
R12	V-COIL COMPLETE (4-WAY VALVE)	1	CWA43C2144J	←	
R13	MULTI BEND TUBE (4-WAY VALVE - CONDENSER)	1	CWT333567	←	
R14	CONDENSER	1	CWB32C1343BX	←	
R15	TUBE ASS'Y	1	CWT023319	←	
R15-1	EXPANSION VALVE	1	CWB051016J	←	
R16	BUSHING	1	CWMH510005	←	
R17	V-COIL COMPLETE (EXPANSION VALVE)	1	CWA43C2058J	←	
R18	DRYER	1	CWB101016	←	
R19	LIQUID RECEIVER HOLDER	1	CWD791001	←	
R20	2-WAY VALVE	1	CWB021129J	←	
R20-1	CAP (VALVE ROD)	2	CWH521098	←	
R22	FLARE NUT (1/4")	1	CWT25086	←	
R23	3-WAY VALVE	1	CWB011165J	CWB011316J	
R23-1	CAP (VALVE ROD)	2	CWH521098	CWH521130	
R23-2	CAP (SERVICE PORT)	1	CWH521099	←	
R25	FLARE NUT	1	CWT25087 (3/8")	CWT25096 (1/2")	
R26	MULTI BEND TUBE (4-WAY VALVE - STRAINER)	1	CWT333568	←	
R27	STRAINER (MULTI BEND TUBE - U-TUBE)	1	CWB111004	←	
R28	U-TUBE (STARINER - CONDENSER)	1	CWT231329	←	
R29	SOUND PROOF BOARD	1	CWG02303	←	
S1	FILTER (OXYGEN GENERATOR) HOLDER - 1	1	CWD911429	←	
S2	FILTER (OXYGEN GENERATOR)	1	CWD071012	←	
S3	FILTER (OXYGEN GENERATOR) HOLDER - 2	1	CWD911430	←	
S5	FLEXIBLE PIPE COMPLETE (2-WAY VALVE - FILTER)	1	CWH851078	←	
S6	2-WAY VALVE (OXYGEN SUPPLY)	1	CWB021126J	←	
S7	FLEXIBLE PIPE COMPLETE (2-WAY VALVE - VACUUM PUMP)	1	CWH851079	←	
S8	TUBE CONNECTOR	1	CWT291049	←	
S9	BELT	1	CWH881060	←	
S10	OXYGEN PUMP	1	CWB532034J	←	
S11	CAPACITOR	1	DS441125QP-E	←	
S13	OXYGEN PUMP MOUNT PLATE	1	CWD911283	←	

REF NO.	DESCRIPTION & NAME	QTY.	CU-HE9DKE	CU-HE12DKE	REMARKS
S14	OXYGEN PUMP SUPPORTING PLATE	1	CWD911284	←	
S15	ANTI-VIBRATION BUSHING (OXYGEN PUMP)	4	CWH501079	←	
S16	BOLT COMPLETE	4	CWH55C1007J	←	
S17	FLEXIBLE PIPE	1	CWH851077	←	
S19	SPACER	1	CWH581003J	←	
S20	TUBE CONNECTOR	1	CWT291029	←	
S21	OXYGEN TUBE - INTER CONNECT	1	CWH85C1032	←	

(Note)

- All parts are supplied from ACD, Japan.
- "O" marked parts are recommended to be kept in stock.